



**COLORADO**  
Department of Transportation

*CDOT Project NO. FBR R200-266*  
*CDOT Subaccount No. 23558*

## STRUCTURE ALTERNATIVES EVALUATION REPORT

Region 2 Bridge Bundle Design Build Grant Project  
Preliminary Design and Procurement Support Services

# Structure M-21-C

(Region 2 – US 350 MP 50.582)



Prepared for: Colorado Department of Transportation Region 2  
5615 Wills Blvd.  
Pueblo, CO 81008

Prepared by: Inna E. Pushkarova, PE  
PushkarovaInna@StanleyGroup.com  
T: 720.460.4742

## Table of Contents

1.	EXECUTIVE SUMMARY .....	4
1.1.	PROJECT DESCRIPTION .....	4
1.2.	PURPOSE OF THE REPORT .....	4
1.3.	STRUCTURE SELECTION PROCESS.....	4
1.4.	STRUCTURE RECOMMENDATIONS.....	5
2.	SITE DESCRIPTION AND DESIGN FEATURES .....	5
2.1.	EXISTING STRUCTURE .....	5
2.2.	RIGHT OF WAY IMPACT .....	8
2.3.	TRAFFIC DETOUR .....	8
2.4.	UTILITIES.....	9
2.5.	GEOTECHNICAL SUMMARY .....	9
2.6.	HYDRAULICS SUMMARY.....	10
2.7.	ENVIRONMENTAL CONCERNS .....	10
2.8.	ROADWAY FEATURES .....	10
3.	STRUCTURAL DESIGN CRITERIA .....	12
3.1.	DESIGN SPECIFICATIONS .....	12
3.2.	CONSTRUCTION SPECIFICATIONS.....	12
3.3.	LOADING.....	12
4.	STRUCTURE SELECTION .....	12
4.1.	SELECTION CRITERIA.....	12
4.2.	REHABILITATION ALTERNATIVES.....	13
4.3.	STRUCTURE LAYOUT ALTERNATIVES.....	13
4.4.	SUPERSTRUCTURE ALTERNATIVES .....	13
4.5.	SUBSTRUCTURE ALTERNATIVES .....	14
4.6.	ACCELERATED BRIDGE CONSTRUCTION (ABC).....	15
4.7.	CONSTRUCTION PHASING .....	15
4.8.	CONSTRUCTABILITY .....	16
4.9.	MAINTENANCE AND DURABILITY.....	16
4.10.	CORROSIVE RESISTANCE.....	17

---

4.11. CONSTRUCTION COST .....	17
4.12. CONCLUSIONS AND RECOMMENDATIONS .....	18
APPENDIX A – General Layout and Typical Section .....	19
APPENDIX B – Structure Selection Report Checklist .....	20
APPENDIX C – Construction Cost Estimate .....	21
APPENDIX D – Geotechnical Report.....	22
Picture 1 - Bridge M-21-C.....	6
Picture 2 - Pier, Overhang, Deck, Girders .....	7
Picture 3 – Corrosion, cracking, efflorescence.....	8
Table 1 - Bridge M-21-C Summary Information.....	6
Table 2 - Summary of Bedrock and Groundwater Conditions .....	9
Table 3 - Construction Cost Summary .....	17
Table 4 - Summary of Structure Alternatives Evaluation.....	18
Figure 1 - Existing Section .....	11
Figure 2 - Proposed Roadway Section .....	11
Figure 3 - Phased Construction .....	16

## 1. EXECUTIVE SUMMARY

### 1.1. PROJECT DESCRIPTION

The CDOT Region 2 Bridge Bundle Design Build Project consists of the replacement of seventeen (17) rural bridges on essential highway corridors in southeastern and central Colorado. The key corridors (US 350, US 24, CO 239 and CO 9) provide rural mobility, intra- and interstate commerce, movement of agricultural products and supplies, and access to tourist destinations. The 2 other bridges are Additionally Requested Elements (AREs) in the design build project. There is a total of nineteen (19) structures bundled under this project.

This design build project is partially funded by the USDOT FHWA Competitive Highway Bridge Program grant and funds from the Colorado Bridge Enterprise (14 structures, project number 23558). The 5 additional structures are funded solely by Colorado Bridge Enterprise (project number 23559). These projects are combined to form one design-build project.

The nineteen bridges identified to be included in the ‘Region 2 Bridge Bundle’ were selected based on similarities in the bridge conditions, risk factors, site characteristics, and probable replacement type, with the goal of achieving economy of scale. Seventeen of the bridges being replaced are at least 80 years old. Five of the bridges are Load Restricted limiting trucking routes through major sections of the US 24 and US 350 corridors. The bundle is comprised of nine timber bridges, four concrete box culverts, one corrugated metal pipe (CMP), four concrete I-beam bridges, and one I-beam bridge with corrugated metal deck.

### 1.2. PURPOSE OF THE REPORT

This report presents the findings of the preliminary level multidisciplinary investigation of the existing conditions of the given structure. The objective of this report is not to select a new structure type but to develop guidelines that will be addressed in the Design-Build documents and make recommendations based on the available information. All the information obtained in the survey, geotechnical investigation, hydrology and hydraulics, existing utilities, and environmental investigation is discussed in this report. The study evaluates feasible structure alternatives for the site and identifies all known constraints.

### 1.3. STRUCTURE SELECTION PROCESS

The following criteria for comparing and evaluating the structural alternatives is discussed below and will need to be considered during design-build processes:

- Hydraulic Opening Requirements
- Roadway alignments
- ROW Impacts
- Constructability
- Construction costs
- Maintenance
- Durability
- Traffic Control

The recommendations of the report are based on the overall consideration of all these elements as appropriate to this site and bridge.

## 1.4. STRUCTURE RECOMMENDATIONS

Based on the subsequent discussion, the recommended proposed overpass structure is a two-span 124.0 ft long bridge with concrete deck over side-by-side BX 24x72 precast prestressed concrete box girders supported by the tall wall cast in place concrete abutments and multi-column pier. The width of proposed construction must accommodate two 12.0 ft lanes of traffic with 6.0 ft shoulders, 2.0 ft shy distance, and the Colorado current standard Bridge Rail on each side.

The contractor may select a different structure type based on their investigation, meeting the criteria described in this report.

## 2. SITE DESCRIPTION AND DESIGN FEATURES

### 2.1. EXISTING STRUCTURE

Existing structure is a three-span concrete deck, steel I beam girder, bridge built in 1937 to span Hoe Ranch Arroyo. The bridge is on a 30-degree skew. The existing bridge consist of three 40'-0" spans (bearing to bearing), with a total length of 126'-0" out to out of abutments. The width of the existing bridge is 30'-0" curb to curb, 33'-6" out to out of deck. The existing vertical clearance is approximately 15'-0".

The existing bridge has 5 rows of girders. The interior girders are W30x116 beams and the two exterior girders are W30x108. The concrete deck is a 8 ¾" reinforced concrete deck with asphalt. The railing is a 9" tall concrete curb with a 2'-0" tall decorative concrete railing. Steel diaphragms are C15x33.9 channels placed at midspan and at supports.

The center piers consist of a 3'-4"x 2'-6" concrete pier caps. Triangular pier capitals, 2'-0" deep connect to 2'-0" square columns supported on 6'-0" square spread footings. The total height of each pier is 18'-10", bottom of footing to top of cap. All concrete is reinforced.

The abutments consist of cast-in-place reinforced concrete wall abutments with wingwalls. Abutment #1 is 41'-2" wide and 22'-7" high. Thickness of the abutment wall varies from 1'-4" to 2'-1". Abutment #1 is supported on a reinforced concrete spread footing, 11'-4" wide. The concrete reinforced wingwalls at Abutment #1 are 58'-0" and 15'-0" long. The thickness of the wingwalls varies from 12" to 1'-7 ½". The wingwalls are supported on a 2'-0" deep reinforced concrete spread footing that varies in width from 7'-4 ½" to 6'-5".

Abutment #4 is 41'-2" wide and 22'-7" high. Thickness of the abutment wall varies from 1'-4" to 2'-1". Abutment #4 is supported on a reinforced concrete spread footing, 11'-4" wide. The concrete reinforced wingwalls at Abutment #4 are 30.0 ft and 15.0 ft long. The thickness of the wingwalls varies from 12" to 1'-7 ½". The wingwalls are supported on a 2'-0" deep reinforced concrete spread footing that vary in width from 7'-4 ½" to 6'-3".

It is located on US 350, southwest of La Junta, at milepost 50.582. Table below summarizes bridge information.

National Bridge Structure Number	M-21-C
Year Built	1937
Construction Type	Concrete on I-Beam
Condition Rating	Poor
Load Restricted	No
Bridge Length	126 feet
Bridge Width	33.5 feet
Number of spans	3
Water Crossing	Hoe Ranch Arroyo
AADT	520
Percent Commercial Traffic	17.7%

**Table 1 - Bridge M-21-C Summary Information**



**Picture 1 - Bridge M-21-C**

The replacement of Bridge M-21-C is warranted due to the age and deteriorating conditions. Cracking has been found on abutments; some 1/16 inches wide. Copper plate is slipping out from beneath Girder 3E at Pier 3. There is visible corrosion on most girders and diaphragms. The underside of the deck has cracking and efflorescence throughout. The deck overhangs have

severe cracking, spalls with exposed reinforcing, active leakage, rust staining, efflorescence, and loose coarse aggregate the full length of the bridge. Photos below show some of the existing bridge deterioration.



**Picture 2 - Pier, Overhang, Deck, Girders**



**Picture 3 – Corrosion, cracking, efflorescence**

## 2.2. RIGHT OF WAY IMPACT

The existing right of way (ROW) is located approximately 75.0 ft each side from the centerline of the existing road. Any alternative selected by a design-build team shall not make an impact on the existing right of way. No permanent ROW acquisitions are planned on either side of the US 350. Temporary construction easements may be required for detour or drainage erosion control.

Fencing is located along the existing right-of-way. Fencing extends perpendicular to the bridge which allows for a cattle crossing.

## 2.3. TRAFFIC DETOUR

As stated by the CDOT grant application, the roadway shall not be closed for construction. Two other alternatives were investigated:

1. Phasing the constructions to keep one lane open. To meet all typical CDOT roadway phased construction criteria, this alternative will require overbuilding the proposed bridge on one side. The width of the proposed structure is contingent upon the girder type and will vary for the alternatives described below.
2. Building a two-lane shoofly on one side of the existing bridge with a temporary pipe placed for drainage. The existing ROW provides enough clearance to construct a shoofly on either side of the bridge. However, due to the relatively long existing bridge structure



and consistently high existing vertical clearance under the bridge, this alternative is considered to be less cost effective than alternative 1, phased construction.

Alternative 1 (phased construction with one lane open) was identified as a preferred traffic alternative for this structure. More information on traffic detour options can be found in the Traffic Design Memorandum for this structure.

## 2.4. UTILITIES

Stanley subcontracted with Lamb-Star Engineering to provide utility location services in the vicinity of the structure. Based on their investigation, the existing utilities in the vicinity of the structure consist of an underground Century Link telephone line. The line runs parallel to the existing ROW line on the east side of the bridge. It is located outside of the ROW, approximately 105.0 ft from the centerline of the existing US 350.

## 2.5. GEOTECHNICAL SUMMARY

Stanley subcontracted with Yeh and Associates, Inc. to perform the geotechnical investigation of all bridges in this project. Full Preliminary Geotechnical Study is provided in the Appendix D.

Two bridge borings, M-21-C-B-1 and M-21-C-B-2, were drilled by Yeh in the vicinity of the existing bridges, and two pavement borings, M-21-C-P-1 and M-21-C-P-2, were drilled along the existing pavement approximately 250 feet from the bridge.

The bridge borings encountered clayey gravel and lean clay soils overlying shale bedrock. Table 2 provides a summary of the bedrock and groundwater conditions for the bridge borings. The surface elevations, approximate bedrock depths/elevations, and approximate groundwater depths/elevations are presented to the nearest 0.5 feet. The groundwater depths and elevations are based on observations during drilling.

Boring ID	Ground Surface Elevation at Time of Drilling <sup>1</sup> (feet)	Approx. Depth to Top of Competent Bedrock <sup>1</sup> (feet)	Approx. Elevation to Top of Competent Bedrock <sup>1</sup> (feet)	Approx. Groundwater Depth <sup>1, 2</sup> (feet)	Approx. Groundwater Elevation <sup>1, 2</sup> (feet)
M-21-C-B-1	4576.5	18.0	4558.5	21.0	4555.5
M-21-C-B-2	4576.5	23.0	4553.5	Not Encountered	Not Encountered

**Table 2 - Summary of Bedrock and Groundwater Conditions**

The recommended substructure foundation types for this site include drilled shafts, driven H-Piles, or spread footing placed directly on the competent bedrock layer. Soft clay layer is not suitable for support of shallow foundations.

## 2.6. HYDRAULICS SUMMARY

Bridge M-21-C crosses the Hoe Ranch Arroyo that flows southeast to the northwest toward Timpas Creek. There is a railroad bridge approximately 1400.0 feet north of the M-21-C bridge.

The drainage is in a mapped floodplain Zone A. The design flow rate is 4359.0 cfs. An SRH-2D model was developed at this location. The proposed model indicates that there is no available CBC alternative that would carry the design flow. A two-span 124.0 ft long bridge alternative was evaluated and was shown to have a sufficient opening to carry design flows.

This stream is considered a low debris stream, therefore 2 ft of freeboard over the design storm is required for a proposed bridge. The proposed bridge option allows for more than 2 ft of freeboard.

A Preliminary Hydraulic Report has been completed and can provide more information about the existing and proposed hydraulics conditions.

## 2.7. ENVIRONMENTAL CONCERNS

Based on field investigation performed by Stanley Consultants Environmental team, no wetlands, sensitive species or other environmental issues of concern have been identified in the vicinity of the bridge.

The Aquatics Resource Report provides the findings at the CDOT bridge M-21-C survey area (12.0 acres), where the OHWM for an ephemeral drainage (R6: 0.58 acres and 635 linear feet) was identified. The drainage is known as the Hoe Ranch Arroyo and drains to the north and into the Timpas Creek, which connects to the Arkansas River. No wetlands were identified in the survey area.

## 2.8. ROADWAY FEATURES

### 2.8.1. Cross Section

Existing US 350 is a 2-lane roadway with two-way traffic. Both lanes are 11.0 ft wide with approximately 3.0 ft shoulders and 1.0 ft curb offset within the limits of the structure.

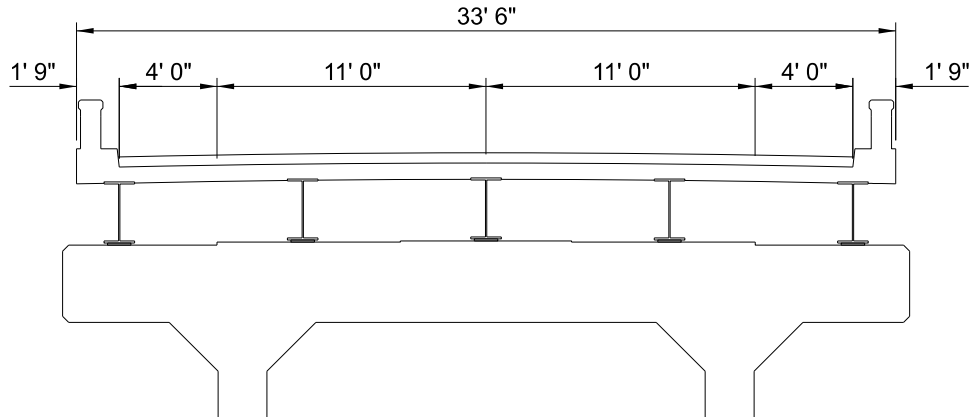

**Figure 1 - Existing Section**

The proposed roadway section width is based on the on the current traffic volumes and the requirements of the current CDOT Roadway Design Guide. Lane width is expected to be 12.0 ft in each direction with 8.0 ft shoulders. Total required roadway width over proposed structure is 40.0 ft. Additional roadway width is needed for phased construction and is discussed in the Section 4.7 Construction Phasing.

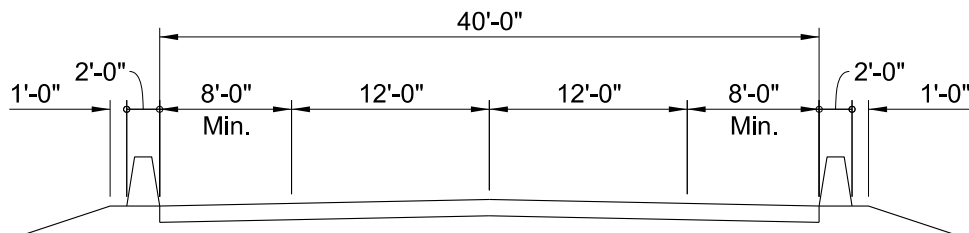

**Figure 2 - Proposed Roadway Section**

### 2.8.2. Vertical Alignment

The proposed vertical profile of US 350 must be set as close to the existing as allowed by the results of the hydrology study to avoid any ROW acquisitions and to limit impacts to the existing roadway section beyond the length of the structure.

The proposed bridge profile is on a 450.0 ft long vertical curve that raises existing roadway profile by a maximum of approximately 4.0 in and an approximate proposed grade of 0.19%. The profile grade is less than 0.5% min recommended by FHWA for bridge decks. Refer to Section 4.3 for more information.

### 2.8.3. Horizontal Alignment

The horizontal alignment of the existing bridge has a 30-degree skew. The bridge is on a continuous horizontal tangent. It is understood that the proposed structure will be constructed in the same location as the existing with no change to the horizontal alignment of the road and skew.

### **3. STRUCTURAL DESIGN CRITERIA**

#### **3.1. DESIGN SPECIFICATIONS**

- AASHTO LRFD Bridge Design Specifications, 9<sup>th</sup> Edition
- CDOT LRFD Bridge Design Manual
- CDOT Bridge Rating Manual
- CDOT Bridge Detail Manual

#### **3.2. CONSTRUCTION SPECIFICATIONS**

Colorado Department of Transportation Standard Specifications for Road and Bridge Construction, 2019.

#### **3.3. LOADING**

*Live Loads:* HL-93 Design Truck or Tandem, Design Lane Load, Colorado Permit Vehicle

*Bridge Barrier:* Colorado current standard Bridge Rail (Bridge Rail Type 9)

*Future Wearing Surface:* 36.67 lbs per square foot (3 in minimum)

*Utilities:* per plan details if required at final design

*Collision Load:* the substructure will not require collision loading design. In cases where Bridge Rail is attached to the structure, the effects of vehicular collision on the barrier must be considered in accordance with AASHTO.

*Earthquake Load:* The structure is located within Seismic Zone 1 and must meet the AASHTO connection and detailing requirements.

*Stream Forces and Scour Effects:* stream force effects must be evaluated during final design when applicable. Possible cases include stream forces on the substructure and superstructure in addition to buoyancy from overtopping. Evaluation from scour will be performed per the CDOT Bridge Design Manual and AASHTO.

### **4. STRUCTURE SELECTION**

#### **4.1. SELECTION CRITERIA**

The goal of this report is to identify which structural alternatives best meet the project requirements. The following criteria were established as a basis for evaluating the suitability of each structure type: hydraulic opening, constructability, construction cost, maintenance & durability, ROW and roadway impacts. The discussion below expands on these factors as it pertains to each alternative. Summary of Structure Alternatives Evaluation Table can be found at the end of Section 4.

## 4.2. REHABILITATION ALTERNATIVES

Rehabilitation of M-21-C will not be performed due to the age and type of the bridge. Constructed in 1937, this structure was in service for over 80 years and is showing signs of deterioration and aging that are inconsistent with practical and cost-effective rehabilitation.

## 4.3. STRUCTURE LAYOUT ALTERNATIVES

Layout of the proposed structure is controlled by the width of the proposed roadway section, stream geometry, hydraulic opening requirements, phased construction considerations and the position of the existing bridge substructure.

Due to the non-redundant configuration of the existing pier, it cannot be partially removed during phased construction. Therefore, any of the proposed superstructure alternatives must be shallow enough to be installed over the existing pier. Existing superstructure is 43.0 in deep. Hydraulic investigation of a two-span bridge alternative with 60.0 ft long spans and 33.0 in superstructure depth was shown to satisfy hydraulic opening requirements. It will provide vertical clearance of approximately 16.67 ft from the bottom of the channel, which is more than the minimum 7.0 ft required for use as a cattle underpass. It will also provide adequate freeboard based on hydraulics elevations provided in the hydrology report. Refer to CDOT Bridge Design Manual and CDOT Drainage Manual for additional clearance requirements information.

The FHWA Design of Bridge Deck Drainage, Hydraulic Engineering publications referred to by CDOT Bridge Design manual states that if the proposed vertical grade is less than 0.5%, the designer must specify a gutter grade that will run the water to the inlet boxed from high points between the boxes. As stated in Section 2.8.2, proposed vertical roadway grade is approximately 0.19%, matching the existing roadway profile. If bridge structure is selected, design team will need to address drainage issues during final design.

The horizontal alignment of the proposed structure will have a 30-degree skew.

Any bridge structure selected for final construction must satisfy the live load deflection requirement for the selected girder types specified in AASHTO LRFD Bridge Design Manual.

## 4.4. SUPERSTRUCTURE ALTERNATIVES

### 4.4.1. Concrete Girder Bridge Alternatives

Selected materials and structure components must exhibit high durability to provide longevity of the bridge. A precast prestressed concrete girder bridge requires minimum maintenance and have been shown to be highly durable under Colorado's harsh conditions. For this project, viable concrete alternatives include precast prestressed box girders or Colorado bulb tee (CBT) shapes.

As explained in Section 4.3, due to the non-redundant configuration of the existing pier, any of the proposed beams must be shallow enough to be installed over the existing pier cap. Proposed girder sizes were selected based on the Table 5B-1 and Figures 5B-1, 5B-2, 5B-4 in the CDOT Bridge Design Manual. Based on this information, BX 24x72 girder section placed side-by-side was chosen as a cost-effective precast concrete solution for the required span. Deck depth for the side-by-side box alternative can be limited to 5.0 in.

#### 4.4.2. Steel Girder Bridge Alternatives

Steel rolled beams or plate girders are also suitable for the given span length. Steel bridges are historically more expensive than concrete bridges in Colorado but can provide longer spans compared to the concrete girder alternatives under equal loading conditions.

LEAP Bridge Steel model was created to provide preliminary composite steel girder design for the span configurations described below. Like the concrete girder alternatives, steel girder section must be shallow enough to span over the existing pier. Depth of the proposed section must be limited to 33.0 in to provide a minimum of 1.0 in of clearance to the existing pier cap. Proposed steel girders are spaced at 6.5 ft with standard 8.0 in deep reinforced concrete deck.

#### 4.4.3. Span Configurations

Total length of the existing structure is 126 ft. The existing substructure is supported by 11.33 ft wide spread-footing placed directly on the bedrock layer. There are a few different approaches that can be taken in construction of the proposed structure:

- Remove existing abutment and re-build proposed abutments in the same location. The removal of the existing substructure can be expensive but would allow for the shortest span. Proposed span lengths for this alternative is 60.0 ft.
- Leave existing spread footing in place and build new abutments behind existing. Drilling through the existing reinforced concrete is generally not recommended, for the purpose of this report, it was assumed that proposed abutment foundation would be installed far enough from the existing to avoid the spread footing. Proposed span for this alternative is 70.0 ft.

Both alternatives will be explored in the discussion below.

According to information provided in CDOT Bridge Design Manual, chosen BX 24x72 girder can be used in 60.0 ft long span lengths. A 30.0 in deep steel girder alternative can accommodate 70.0 ft span lengths.

### 4.5. SUBSTRUCTURE ALTERNATIVES

Feasible abutment substructure types considered in this study are integral abutments supported on deep foundations (H-piles or drilled caissons), or wall type abutments supported on spread footings.

Wall type abutment alternative will be used for 60.0 ft span option, where a lot of required excavation will be done during existing abutment removal process. Tall wall width is assumed to be 2.5 ft wide based on Figure 11-6 in CDOT Bridge Design Manual. Footing is assumed to be 2.0 ft deep and 11.33 ft wide to match existing spread footing and based on preliminary bearing capacity calculations. Required wingwall lengths are 20.0 ft & 40.0 ft at the south abutment and 20.0 ft & 40.0 ft at the north abutment based on the roadway tow of slope model. Wingwalls for this alternative will be connected to tall wall abutment and bearing on a 2.0 ft deep, 8.0 ft wide spread-footing foundation.

Integral abutment alternative with a maximum allowed depth of 6.0 ft will be used for 70.0 ft span option (see Figure 11-1 in CDOT Bridge Design Manual). Abutment cap will be supported

by (7) 24.0 in diameter drilled shafts. Drilled shafts were selected for the purpose of this report due to the concerns that H-piles would not be able to get sufficient embedment into the hard bedrock layer to provide adequate lateral resistance. Note that portion of the existing substructure can be left in place if this alternative is selected. This type of abutment might be susceptible to scour and can be mediated by placing riprap around abutments and wingwalls. It is assumed that by providing deeper abutment cap and channel grading, it will be possible to avoid building MSE retaining wall in front of the integral abutment. Wingwalls for this alternative will consist of either integral wingwall attached to the abutment cap (up to 20.0 ft max), or a combination of 10.0 ft integral wingwall with an independent wingwall to achieve the required design length.

Feasible pier substructure types considered in this study are multi-column piers supported on either deep foundations (H-piles or drilled caissons) or spread footings. The center pier consists of a 3'-0" x 3'-0" concrete pier cap supported by two 2'-6" square columns. The total height of the pier is approximately 18'-0", from top of footing to top of cap. All concrete is reinforced.

Spread footings can be used for both the 60.0 ft span option and the 70.0 span option. The size of the footing per column depends on span arrangement. The 60.0 ft span option has assumed 2.5 ft deep by 9.5 ft square footings and the 70.0ft span option has assumed 2.5 ft deep by 10.0 ft square footings. Footing dimensions are based on preliminary bearing capacity calculations.

Again, drilled shafts were selected rather than driven H-piles due to the concern of attainable embedment depth of the H-piles into the hard bedrock layer. As such, each column would be supported by a single oversized drilled shaft as detailed in Figure 11-13 of the CDOT Bridge Design Manual. Preliminary calculations indicate 54.0 in and 60.0 in drilled shafts for the 60.0 ft span option and the 70.0 ft span option, respectively.

#### 4.6. ACCELERATED BRIDGE CONSTRUCTION (ABC)

CDOT has developed an Accelerated Bridge Construction (ABC) decision making process. The intent of this process is to apply some form of ABC on most projects. Design-build team is encouraged to use these recourses to evaluate cost efficiency of implementing ABC design.

#### 4.7. CONSTRUCTION PHASING

As discussed in Section 2.3, building a shoefly at this location might not be cost effective. Phased construction is feasible and recommended.

Based on the CDOT Roadway requirements, a minimum required roadway configuration for each phase of the construction must consist of 11.0 ft lane, 2.0 ft shoulder on each side, 2.0 ft wide temporary concrete barrier, 1.0 ft min. work zone buffer with pinned barrier and 2.0 ft min. work zone buffer with non-pinned barrier. To accommodate these requirements, bridge deck section will require some amount of overbuild (compare to the approaching roadway section). Figures below show required phasing configurations for concrete and steel superstructure alternatives. Concrete girder alternative requires wider superstructure due to the width of the proposed girders. Steel girder alternative is more flexible with the location of the phased removal and allows for narrower superstructure. More information on phased construction can be found in the Traffic Design Memorandum for this structure.

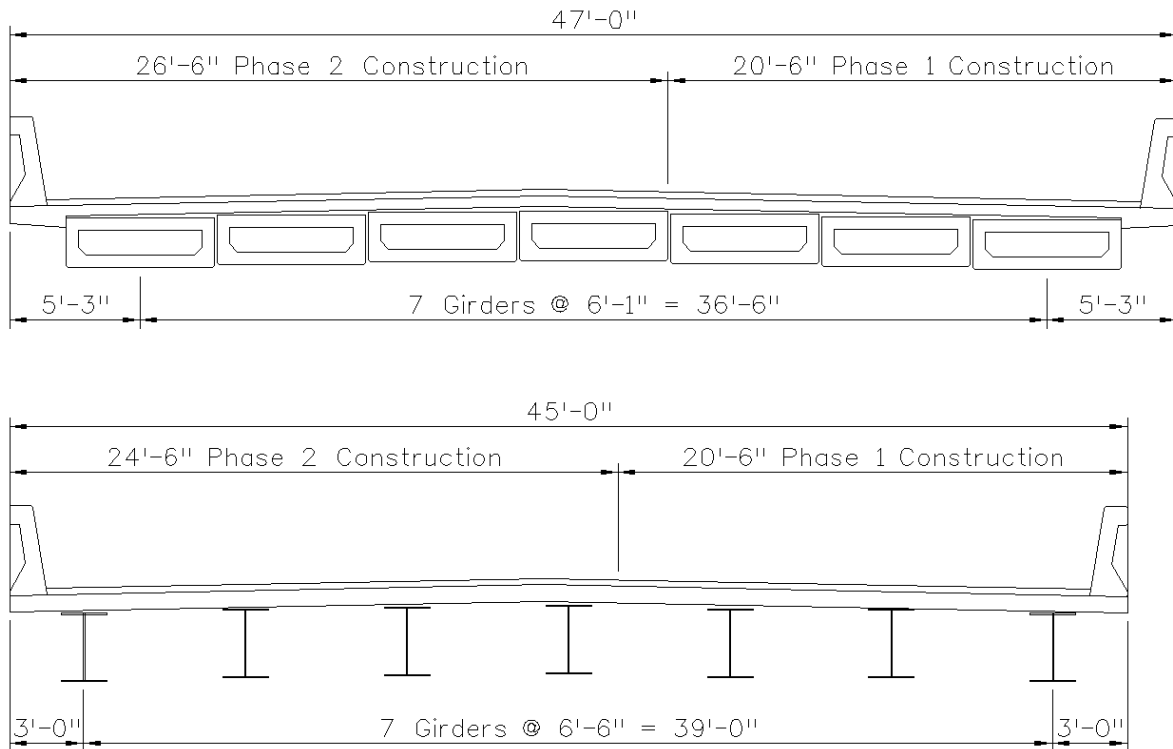

**Figure 3 - Phased Construction**

#### 4.8. CONSTRUCTABILITY

Some amount of rock excavation is expected for tall wall on spread footing abutment alternative to remove a layer of the deteriorated bedrock, and any bedrock damaged during existing structure removal. For the purpose of this report, proposed spread footing elevation was set about 1.0 ft below the existing footing.

Preliminary Geotechnical Study report notes that bedrock may be very hard at various elevations. If drilled shaft option is chosen as final foundation alternative, the contractor should mobilize equipment of sufficient size and operating condition to achieve the required design bedrock penetration.

#### 4.9. MAINTENANCE AND DURABILITY

Typical CDOT specified materials and construction methods must be used for the construction of the proposed structure. Following accepted current practice in designing and constructing the structure will provide a durable bridge to meet the required 100-year service life with minimal required maintenance.

Painted steel superstructures require frequent routine maintenance and repainting. Weathering steel can be used to eliminate the maintenance issues of painting, but it has other similar maintenance issues as painted steel.

There is very little maintenance associated with the concrete girder bridge alternative.



#### 4.10. CORROSIVE RESISTANCE

Epoxy coated reinforcing must be used for all reinforced concrete elements. A waterproofing membrane and stone matrix asphalt will be used on top of the concrete deck or CBC to prevent water and salt intrusion.

Steel bridge alternative must use weathered or painted steel girders.

#### 4.11. CONSTRUCTION COST

Construction costs are one of the most important factors in the structure type selections. Preliminary construction cost estimates are prepared for all selected structure alternatives to be compared as discussed above. High level construction cost for each structure type is summarized in the table below. Detailed calculations of the cost can be found in the Appendix C of this report. Individual items cost was obtained from recent CDOT Cost Data Books. 30% contingency multiplier was used in cost calculations.

Summary of the alternatives:

*Concrete Bridge Alternative* – Two span, 60.0 ft bearing to bearing span length, 47.0 ft superstructure width, (7) BX 24x72 girders side by side per span, 5.0 in reinforced deck, tall wall abutment on spread footing, integral wingwalls on footings and multi-column pier supported on spread footings.

*Steel Bridge Alternative* – Two span, 70.0 ft bearing to bearing span length, 45.0 ft superstructure width, (7) 30.0 in deep steel plate girders spaced at 6.5 ft per span, 8.0 in reinforced deck, integral abutments on (7) 24.0 in drilled shafts spaced at 7.83 ft and multi-column pier supported on 60.0 in drilled shafts.

Alternative	Construction Cost (30% Contingency)	Area	Cost per sq.ft	Cost Rating
Concrete Bridge Alternative	\$ 2,132,000.00	5828 sq.ft	\$ 366.00	1.0
Steel Bridge Alternative	\$ 2,065,000.00	6480 sq.ft	\$ 319.00	1.1

**Table 3 - Construction Cost Summary**

#### 4.12. CONCLUSIONS AND RECOMMENDATIONS

Table below provides a summary of feasible alternatives evaluation based on the established selection criteria

Criteria	Concrete Bridge	Steel Bridge
Hydraulic Opening	Satisfies the requirements	Satisfies the requirements
Constructability	Removal of the existing structure might present some difficulty due to the size of the existing structure	Drilling into the existing hard bedrock to the min 3D depth or enough achieve longitudinal capacity may present some difficulty
Construction Cost Rating	1.0	1.1
Maintenance & Durability	Concrete girders require minimal maintenance.  Tall wall abutments bearing on bedrock are preferred alternative in scour conditions.	Steel girders require regular cleaning and/or painting.  Integral abutment on drilled shafts will require scour protection.
ROW and Roadway Impacts	No ROW impacts	No ROW impacts.

**Table 4 - Summary of Structure Alternatives Evaluation**

Based on the criteria discussed above, despite the higher cost, the concrete bridge alternative is the recommended alternative to replace existing M-21-C bridge. In our opinion, the maintenance required for the steel bridge alternative over the life span of the bridge will not justify the savings. The contractor may select a different structure type based on their investigations, meeting the criteria described in this report. See Appendix A for the selected General Layout and Typical Section.

# **APPENDIX A**

General Layout and Typical Section

9365 9:33:23 PM p:\SCI-PW\NTEG-2.stanleygroup.com\Datagroup\Colorado\_Department\_of\_Transportation\29715 - CDDT R2 Bridge Bundle\11-CADD\Worksets\29175\Drawings\Bridges\General Layout M-21-C-SH350 MP 50.58.dgn



Know what's below.  
Call before you dig.

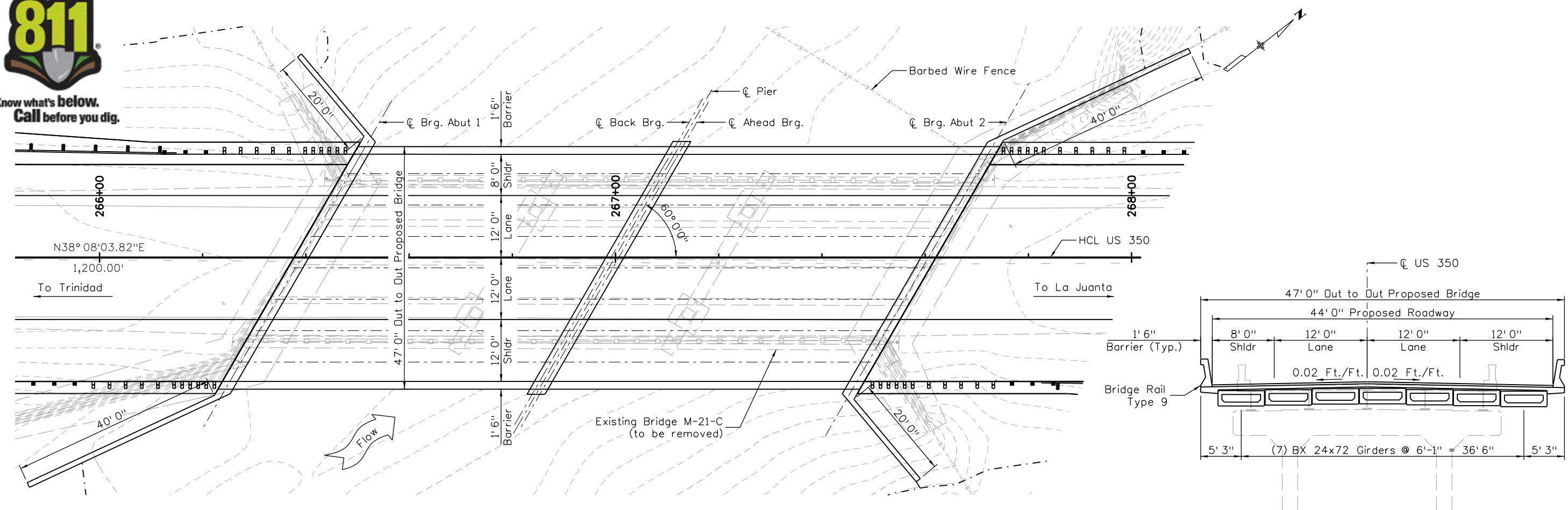

**PLAN**

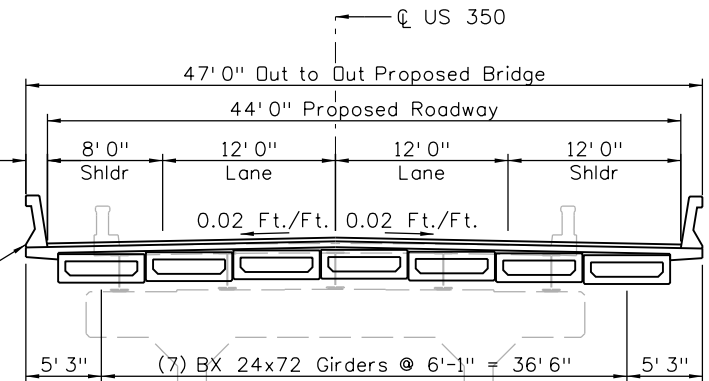

**SECTION**

(Taken Normal to HCL US 350)

- Notes:
- Dimensions are based on recent survey and existing as-built drawings.

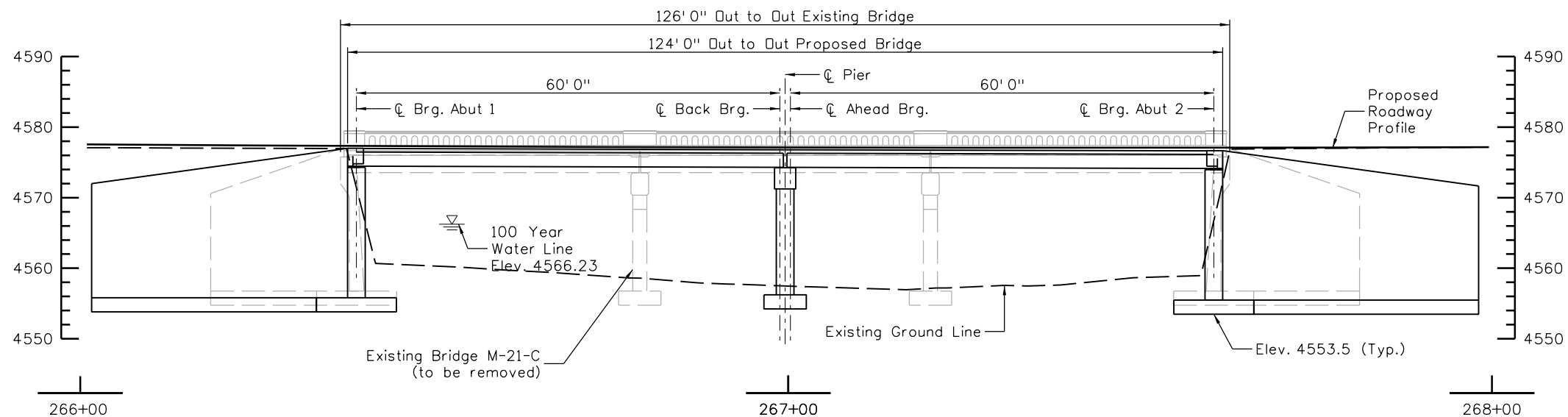

**ELEVATION**

(Taken Along HCL US 350)

Print Date: 2/2/2021	File Name: 23558STR_General Layout M-21-C-SH350 MP 50.58.dgn	Sheet Revisions			Colorado Department of Transportation 5615 Wills Blvd Pueblo, CO 81008 Phone: 719-546-5753 FAX: 719-546-5402	As Constructed No Revisions:	REGION 2 BRIDGE BUNDLE US 350 OVER SEASONAL DRAW GENERAL LAYOUT AND TYP. SECTION			Project No./Code
Horiz. Scale:	Vert. Scale: As Noted	Date:	Comments:	Init.:			Revised:	Designer: I. Pushkarova	Structure No.:	M-21-C
Stanley Consultants INC. 8000 South Chester St. Suite 500 Centennial, CO 80112 Phone: 303-799-6806		Region 2			JLS	Void:	Detailer: I. Pushkarova	M.P.:	US 350 50.582	Sheet Number
							Sheet Subset: STR	Subset Sheets:	1 of 1	

# **APPENDIX B**

## Structure Selection Report Checklist

# Structure Selection Report QA Checklist

This checklist is to serve as a general guideline for structure selection process. It is to be filled out by the project Engineer of Record or designee to indicate all items that are to be discussed in the Structure Selection Report. This checklist is to be included as an appendix to the Structure Selection Report and must be signed by Staff Bridge Unit Leader or designee prior to submittal of FIR documents to the Region.

Project Name \_\_\_\_\_

Project Location \_\_\_\_\_

Project Number \_\_\_\_\_ Subaccount \_\_\_\_\_

Structure Number(s) \_\_\_\_\_

Engineer of Record \_\_\_\_\_ Date \_\_\_\_\_

## Cover Sheet

- Name of the Project and Site Address
- Structure(s) Number
- Property Owner Name and Contact Information
- Report Preparer Name and Contact Information
- Seal and Signature of the Designer
- Submittal and Revision Dates as Applicable

## Executive Summary

- Project Description
- Purpose of the Report
- Structure Selection Process
- Structure Recommendations

## Site Description and Design Features

- Existing Structures
- ROW Impact
- Traffic Detour
- Utilities
- Geotechnical Summary
- Hydraulics Summary
- Environmental Concerns
- Roadway Design Features
  - Cross Section
  - Vertical Alignment
  - Horizontal Alignment

## Structural Design Criteria

- Design Specifications
- Construction Specifications
- Loading
  - Collision Load
  - Earthquake Load
- Software to be used by the Designer
- Software to be used by the Independent Design Checker

## Structure Selection

- Selection Criteria
- Rehabilitation Alternatives
- Structure Layout Alternatives:
  - Vertical Clearances
  - Horizontal Clearances
  - Deflection
  - Skew

- Superstructure Alternatives:
  - Concrete Girder Alternatives
  - Steel Girder Alternatives
  - Span Configurations
- Substructure Alternatives:
  - Abutment Alternatives (GRS, Integral, Semi-integral, etc.)
  - Pier Alternatives
- Wall Alternatives
- Construction Phasing
- Possible Future Widening
- Use of Existing Bridge in Phasing / Partial Configuration
- ABC Design
- Constructability
- Aesthetic Design
- Maintenance and Durability
- Corrosive Resistance
- Load Testing Requirements
- Use of Lightweight Concrete
- Construction Cost
- Life Cycle Cost Analysis

**Other**

---



---

**Figures and Appendices**

- Vicinity Map
- Alternative Typical Sections
- General Layout of the Selected Structure
- Summary of Structure Type Evaluation Table
- Summary of Quantities and Cost Estimate Tables
- Inspection Report
- Hydraulics Investigation Results
- Geotechnical Investigation Results

**Recommendations**

---



---



---



---

*If you need more space, use an additional sheet(s) of paper.*

**List of Variances**

---



---



---



---

*If you need more space, use an additional sheet(s) of paper.*

**CDOT Staff Bridge Quality Assurance Sign-off**

By signing this checklist Staff Bridge Unit Leader or designee acknowledges approval of the Structure Selection Report findings, recommendations, and all design deviations from the CDOT Structural Standards and design criteria.

---



---



---

Print Name

Signature

Date

# **APPENDIX C**

## Construction Cost Estimate



Project No.: CDOT #23558 (Stanley #29715)  
 Project Name: Region 2 Bridge Bundle Design Build Grant Project  
 Subject: Quantity Calculations - M-21-C Concrete Bridge Alternative  
 Client: CDOT Region 2

Date: 2/2/2021

<b>CONCRETE BRIDGE ALTERNATIVE</b>					
<b>Contract Item No.</b>	<b>Item Description</b>	<b>Unit</b>	<b>Estimated Unit Cost</b>	<b>TOTAL</b>	
				<b>Approx Quantities</b>	<b>Estimated Total Cost</b>
<b>202-00400</b>	Removal of Bridge	EACH	\$ 90,000.0	1	\$ 90,000
<b>203-00400</b>	Rock Excavation	CY	\$ 42.00	114	\$ 4,809
<b>206-00000</b>	Structure Excavation	CY	\$ 20.00	4880	\$ 97,593
<b>206-00100</b>	Structure Backfill (Class 1)	CY	\$ 35.00	3880	\$ 135,792
<b>206-01750</b>	Shoring	L S	\$ 12,000.0	2	\$ 24,000
<b>420-00102</b>	Geotextile (Erosion Control) (Class 1)	SY	\$ 7.0	497	\$ 3,478
<b>506-00000</b>	Riprap	CY	\$ 120.0	497	\$ 59,640
<b>515-00120</b>	Waterproofing (Membrane)	SY	\$ 22.50	706	\$ 15,875
<b>601-04550</b>	Concrete Class G	CY	\$ 900.00	562	\$ 506,239
<b>601-40300</b>	Structural Concrete Coating	SY	\$ 14.00	895	\$ 12,534
<b>602-00000</b>	Reinforcing Steel	LB	\$ 3.72	92699	\$ 344,840
<b>606-10900</b>	Bridge Rail Type 9	LF	\$ 152.00	248	\$ 37,696
<b>618-01992</b>	Prestressed Concrete Box (Depth Less Than 32 Inches)	SF	\$ 60.00	5124	\$ 307,440
<b>Subtotal of accounted construction items =&gt;</b>					<b>\$ 1,639,937</b>
<b>Contingency Multiplier =&gt;</b>					<b>30%</b>
<b>Subtotal of construction items =&gt;</b>					<b>\$ 2,131,918</b>
<b>Deck area (SF) =&gt;</b>					<b>5828</b>
<b>Cost per SF =&gt;</b>					<b>\$ 366</b>



# **APPENDIX D**

Geotechnical Report



February 10, 2021

Project No. 220-063

Mr. Ron Gibson, P.E.  
Stanley Consultants  
8000 South Chester Street, Suite 500  
Centennial, Colorado 80112

**Subject: Preliminary Geotechnical Study  
Structure M-21-C  
23558/23559 Region 2 Bridge Bundle  
CDOT Region 2, Colorado**

Dear Mr. Gibson:

This memorandum presents the results of Yeh and Associates, Inc.'s (Yeh) preliminary geotechnical engineering study for the proposed replacement of Structure M-21-C as part of the CDOT Region 2 Bridge Bundle Design-Build Project.

The CDOT Region 2 Bridge Bundle Design-Build Project consists of the replacement of a total of 19 structures bundled together as a single project. These structures are rural bridges on essential highway corridors (US 350, US 24, CO 239, and CO 9) in southeastern and central Colorado. These key corridors provide rural mobility, intra- and interstate commerce, movement of agricultural products and supplies, and access to tourist destinations. The design-build project consists of 17 bridges and two Additionally Requested Elements (ARE) structures.

This design-build project is jointly funded by the USDOT FHWA Competitive Highway Bridge Program grant (14 structures, Project No. 23558) and the Colorado Bridge Enterprise (five structures, Project No. 23559). These projects are combined to form one design-build project. The two ARE structures are part of the five bridges funded by the Colorado Bridge Enterprise.

The 19 bridges identified to be included in the Region 2 Bridge Bundle were selected based on similarities in the bridge conditions, risk factors, site characteristics, and probable replacement type, with the goal of achieving economy of scale. Seventeen of the bridges being replaced are at least 80 years old. Five of the bridges are load-restricted, limiting trucking routes through major sections of the US 24 and US 350 corridors. The bundle includes nine timber bridges, four concrete box culverts, one corrugated metal pipe (CMP), four concrete I-beam bridges, and one I-beam bridge with corrugated metal deck.

## **1 PROJECT UNDERSTANDING**

Bridge M-21-C is part of the Region 2 Bridge Bundle project that will be delivered as a design-build project. Our preliminary geotechnical study was completed to support the 30% design level that will be included in the design build bid package. We understand the existing structure will be replaced with either a concrete box culvert (CBC) or a bridge structure. The new structure will be constructed along the current roadway alignment and existing

roadway grade will be maintained. No significant cut or fills are required for construction of the proposed replacement structure.

## 2 SUBSURFACE CONDITIONS

Two bridge borings, M-21-C-B-1 and M-21-C-B-2, were drilled by Yeh in the vicinity of the existing bridges, and two pavement borings, M-21-C-P-1 and M-21-C-P-2, were drilled along the existing pavement approximately 250 feet from the bridge. The approximate boring locations are shown on the engineering geology sheet in Appendix A. The legend and boring logs are included in Appendix B. Laboratory test results are provided in Appendix C and are shown on the boring logs.

The bridge borings encountered clayey gravel and lean clay soils overlying shale bedrock. Table 1 provides a summary of the bedrock and groundwater conditions for the bridge borings. The surface elevations, approximate bedrock depths/elevations, and approximate groundwater depths/elevations are presented to the nearest 0.5 feet. The groundwater depths and elevations are based on observations during drilling.

**Table 1. Summary of Bedrock and Groundwater Conditions**

Boring ID	Location <sup>1</sup> (Northing, Easting)	Ground Surface Elevation at Time of Drilling <sup>1</sup> (feet)	Approx. Depth to Top of Competent Bedrock <sup>1</sup> (feet)	Approx. Elevation to Top of Competent Bedrock <sup>1</sup> (feet)	Approx. Groundwater Depth <sup>1, 2</sup> (feet)	Approx. Groundwater Elevation <sup>1, 2</sup> (feet)
M-21-C-B-1	402438.098, 480947.340	4576.5	18.0	4558.5	Not Encountered	Not Encountered
M-21-C-B-2	402308.859, 480864.836	4576.5	23.0	4553.5	21.0	4555.5

Notes:

(1) Surface elevations, approximate bedrock depths/elevations, and approximate groundwater depths/elevations are presented to the nearest 0.5 feet. Location and elevation are provided by project surveyor.

(2) Groundwater depths and elevations are based on observations during drilling.

## 3 BRIDGE FOUNDATION RECOMMENDATIONS

We understand that the replacement structure will consist of either a new bridge structure or a concrete box culvert structure (CBC). If a bridge structure is selected, then the abutments and piers will be supported on driven H-piles, drilled shafts, or shallow foundations. If a CBC structure is selected, then the structure will be founded on a shallow mat foundation. Wing walls for the bridge and CBC structures will be founded on shallow strip foundations.

Based on the subsurface conditions encountered during our preliminary study, our engineering analysis, and our experience with similar projects, it is our opinion that driven H-pile and drilled shaft foundations are suitable for support of the bridge structure. Shallow foundations are suitable for support of the CBC and wing wall structures and may be suitable for the support of the bridge structure. Recommendations for shallow foundations are presented in Section 3.1, drilled shaft recommendations are presented in Section 3.2, driven H-pile recommendations are provided in Section 3.3, and CBC foundation recommendations are presented in Section 3.4.



The soil and bedrock properties were estimated from penetration resistance, material descriptions, and laboratory data. The design and construction of the foundation elements should comply with all applicable requirements and guidelines listed in AASHTO (2020) and the CDOT Standard Specifications (CDOT 2019).

### **3.1 Shallow Foundation Recommendations**

Based on the depth to bedrock and the anticipated loading requirements, shallow foundations such as reinforced concrete strip footings may be suitable to support the bridge structure. Alternatively, a Geosynthetic Reinforced Soil – Integrated Bridge System (GRS-IBS) may be considered. We recommend the FHWA GRS-IBS Implementation guide (FHWA-HRT -11-026) and Synthesis report (FHWA-HRT-11-027) be followed for the design and construction of the GRS-IBS system. Design and construction for the shallow foundation or GRS-IBS system should take into consideration the scour potential at the proposed bridge site.

We anticipate that the bearing resistance of the shallow foundations will meet the project loading requirements provided that the shallow foundations are founded on competent bedrock. The bottom of GRS-IBS structures should be founded directly on competent bedrock. Existing surficial soils and weathered bedrock should be over-excavated to the top of competent bedrock prior to placement of shallow foundations or GRS-IBS.

Visual inspection of the foundation excavations should be performed by a qualified representative of the Geotechnical Engineer of record to identify the quality of the foundation materials prior to construction of the foundation. Groundwater may be encountered during excavation for the subgrade preparation. Groundwater control systems may be required to prevent seepage migrating into the construction zone by creating groundwater cut-off and/or dewatering systems.

### **3.2 Drilled Shaft Recommendations**

#### **3.2.1 Drilled Shaft Nominal Axial Resistance**

The estimated bearing resistance should be developed from the side and tip resistance in the underlying very hard bedrock. The resistance from the overburden soil should be neglected. The design approach in Abu-Hejleh et al. (2003) provides recommendations for the use of an updated Colorado SPT-based (UCSB) design method. In this design method, the nominal side and tip resistance of a drilled shaft in the sedimentary bedrock is proportional to the driven sampler penetration resistance. This approach was generally used to estimate the axial resistance in the bedrock. Based on local practice, the modified California penetration resistance is considered to be equivalent to a standard penetration test (SPT) penetration resistance, i.e. N value, in bedrock.

Table 2 contains the recommended values for the nominal side and tip resistance for drilled shafts founded in the underlying very hard bedrock. The upper three feet of competent bedrock penetration shall not be used for drilled shaft resistance due to the likelihood of construction disturbance and possible additional weathering. To account for axial group effects, the minimum spacing requirements between drilled shafts should be three diameters from center-to-center.

**Table 2. Recommended Drilled Shaft Axial Resistance**

Reference Boring	Approximate Top of Competent Bedrock Elevation (feet)	End Bearing (ksf)		Side Resistance, (ksf)	
		Nominal	Factored ( $\Phi=0.5$ )	Nominal	Factored ( $\Phi=0.45$ )
M-21-C-B-1	4558.5	110	55	12.5	5.6
M-21-C-B-2	4553.5	150	75	15	6.7

### 3.2.2 Drilled Shaft Lateral Resistance

The input parameters provided in Table 3 are recommended for use with the computer program LPILE to develop the soil models used to evaluate the drilled shaft response to lateral loading. Table 3 provides the estimated values associated with the soil types encountered in the borings. They can also be used for driven H-piles, which will be described in Section 3.3. The nature and type of loading should be considered carefully. Individual soil layers and their extent can be averaged or distinguished by referring to the boring logs at the locations of the proposed bridge. The soils and/or bedrock materials prone to future disturbance, such as from utility excavations or frost heave, should be neglected in the lateral load analyses to the depth of disturbance, which may require more than but should not be less than three feet.

Recommendations for p-y multiplier values ( $P_m$  values) to account for the reduction in lateral capacity due to group effects are provided in Section 10.7.3.12 of AASHTO (2020). The  $P_m$  value will depend on the direction of the applied load, center-to-center spacing, and location of the foundation element within the group.

**Table 3. LPILE Parameters**

Soil Type	LPILE Soil Criteria	Effective Unit Weight (pcf)		Friction Angle, (deg.)	Undrained Cohesion, (psf)	Strain Factor, $\epsilon_{50}$	p-y modulus kstatic (pci)	
		AGT <sup>1</sup>	BGT <sup>2</sup>				AGT <sup>1</sup>	BGT <sup>2</sup>
Class 1 Structure Backfill	Sand (Reese)	130	67.5	34	-	-	90	60
Fill/Native Sand and Gravel	Sand (Reese)	125	62.5	31	-	-	25	20
Clay	Stiff Clay w/o Free Water (Reese)	120	57.5	-	450	0.01	-	-
Shale Bedrock	Stiff Clay w/o Free Water (Reese)	130	130	-	8,000	0.004	-	-

Note: <sup>1</sup>Above Groundwater Table  
<sup>2</sup>Below Groundwater Table

### 3.2.3 General Drilled Shaft Recommendations

The following recommendations can be used in the design and construction of the drilled shafts.



- Groundwater and potentially caving soils may be encountered during drilling depending on the time of year and location. The Contractor shall construct the drilled shafts using means and methods that maintain a stable hole.
- Bedrock may be very hard at various elevations. The contractor should mobilize equipment of sufficient size and operating condition to achieve the required design bedrock penetration.
- Drilled shaft construction shall not disturb previously installed drilled shafts. The drilled shaft concrete should have sufficient time to cure before construction on a drilled shaft within three shaft diameters (center to center spacing) begins to prevent interaction between shafts during excavation and concrete placement.
- Based on the results of the field investigation and experience with similar properly constructed drilled shaft foundations, it is estimated that foundation settlement will be less than approximately ½ inch when designed according to the criteria presented in this report.
- A representative of the Contractor’s engineer should observe drilled shaft installation operations on a full-time basis.

### **3.3 Driven H-Pile Recommendations**

#### **3.3.1 Driven H-Pile Axial Resistance**

Steel H-piles driven into bedrock may be designed for a nominal axial resistance equal to 32 kips per square inch (ksi) multiplied by the cross-sectional area of the pile for piles composed of Grade 50 ksi steel for use with LRFD Strength Limit State design. Piles should be driven to refusal into the underlying bedrock as defined in Section 502.05 of CDOT (2019). A wave equation analysis using the Contractor’s pile driving equipment is necessary to estimate pile drivability.

#### **3.3.2 Driven H-Pile Axial Resistance Factors**

Assuming a pile driving analyzer (PDA) is used to monitor pile driving per Section 502 of CDOT (2019), a resistance factor of 0.65 may be used per AASHTO (2020) Table 10.5.5.2.3-1. Section 502.05 of CDOT (2019) stipulates that if PDA is used, a minimum of one PDA per bridge bent be performed to determine the condition of the pile, efficiency of the hammer, static bearing resistance of the pile, and to establish pile driving criteria. Per AASHTO (2020) recommendations, a resistance factor of 0.5 can be used for wave equation analysis only without pile dynamic measurements such as PDA monitoring. Per AASHTO (2020) recommendations, a resistance factor of 0.75 may be used if a successful static load test is conducted per site condition.

#### **3.3.3 Driven H-Pile Lateral Resistance**

The information provided previously in Section 3.2.2 may be used to evaluate H-pile lateral resistance.

#### **3.3.4 General Driven H-Pile Recommendations**

The following recommendations are for the design and construction of driven H-piles.

1. Based on the results of the field exploration and our experience with similar properly constructed driven pile foundations, it is estimated that settlement will be less than approximately ½ inch when designed according to the criteria presented in this report.
2. A minimum spacing requirement for the piles should be three diameters (equivalent) center to center.
3. Driven piles should be driven with protective cast steel pile points or equivalent to provide better pile tip seating and to prevent potential damage from coarse soil particles, which may be present at the site.





4. A qualified representative of the Contractor’s engineer should observe pile-driving activities on a full-time basis. Piles should be observed and checked for crimping, buckling, and alignment. A record should be kept of embedment depths and penetration resistances for each pile.
5. It is estimated that the piles will penetrate approximately 3 to 5 feet into competent bedrock (see Table 1 for the estimated elevation for the top of competent bedrock). The final tip elevations will depend on bedrock conditions encountered during driving.
6. If the pile penetration extends below the estimated pile penetration into bedrock by 10 feet or more, the pile driving operations should be temporarily suspended for dynamic monitoring with PDA. We recommend that the subject pile be allowed to rest overnight or longer before restriking and monitoring the beginning-of-restrike with a PDA. The data collected with the PDA shall then be reduced using the software CAPWAP to determine the final nominal pile resistance. The pile driving criteria may be modified by CDOT’s or the Contractor’s engineer based on the PDA/CAPWAP results.

### 3.4 CBC Foundation Recommendations

Shallow bedrock was encountered in M-21-C-B-1. Bedrock encountered within 2 feet of the bottom of the foundations should be over-excavated to allow for a minimum of 2-feet of structural fill below the CBC and wing wall foundations extending to the top of bedrock. To assure adequate foundation support and to minimize the potential for differential settlement, we recommend that the exposed subgrade soils should be scarified a minimum of 6 inches, moisture conditioned, and re-compacted in accordance with Section 203.07 of the CDOT Standard Specifications (2019) before the placement of structural elements or structural backfill. If unsuitable or soft materials are encountered after the excavation, the materials may be removed and replaced with CDOT Class 1 Structure Backfill in accordance with Section 203.07 of the CDOT Standard Specifications (2019). Visual inspection of the foundation excavations should be performed by a qualified representative of the Geotechnical Engineer of record to identify the quality of the foundation materials prior to placement of backfill and the CBC. Groundwater may be encountered during excavation for the subgrade preparation. Groundwater control systems may be required to prevent seepage migrating into the construction zone by creating groundwater cut-off and/or dewatering systems.

The recommended nominal bearing resistance using Strength Limit State for the CBC and associated wing walls for both moist and saturated conditions are provided in Table 4. We assume the materials in contact with the bottom of the proposed CBC and wing walls will consist of native clay soils or CDOT Class 1 Structure Backfill placed in accordance with Section 203.07 of the CDOT Standard Specifications (2019). The reduced footing width due to eccentricity can be calculated based on the recommendations in Sections 11.6.3.2 and 11.10.5.4 of AASHTO (2020). A bearing resistance factor of 0.45 may be used for shallow foundations based on the recommendations in Table 10.5.5.2.2-1 of AASHTO (2020).

**Table 4. Bearing Resistance for CBC and Wing Walls on Shallow Foundation**

Soil Conditions	Nominal Bearing Resistance (ksf) <sup>1, 2</sup>
Moist	$2.0 + 1.0 * B'$
Saturated	$1.0 + 0.5 * B'$

<sup>1</sup> B' is the footing width in feet reduced for eccentricity (e).  $B' = B - 2e$ , where B is the nominal foundation width.  
<sup>2</sup> The calculated nominal bearing resistance is based on a minimum 12 inches of embedment and shall be limited to 15 ksf.



The proposed CBC will be at the location of the existing CBC, and as needed, a portion of the CBC will be in a cut area, therefore it is estimated that the total settlement of the structure will be minimal and will occur during construction. The structure settlement is partially controlled by the weight of the adjacent embankment fill. Thus, it is recommended that the embankment fill on both sides of the CBC be placed at a relatively uniform elevation.

Resistance to sliding at the bottom of foundations can be calculated based on a coefficient of friction at the interface between the pre-cast concrete and the existing native soils or compacted CDOT Class 1 Structure Backfill. The recommended nominal coefficients of friction and the corresponding resistance factors for Class 1 Structure Backfill and native soils are provided in Table 5.

**Table 5. Coefficients of Friction for CBC and Wing Walls on Shallow Foundation**

Foundation Soil Type	Coefficient of Friction	Resistance Factor
Class 1 Structure Backfill	0.53	0.9
Native Clay	0.30	0.8
Native Sand/Gravel	0.34	0.8

Backfill adjacent to the CBC should be Class 1 Structure Backfill, compacted with moisture density control. Backfill materials shall have a Class 0 for severity of sulfate exposure. Fill should be tested for severity of sulfate exposure prior to acceptance.

The passive pressure against the sides of the foundation is typically ignored; however, passive resistance can be used if long-term protection from disturbance, such as frost heave, future excavations, etc., is assured. Table 6 presents recommendations for the passive soil resistances for the encountered soil conditions. The passive resistance estimates are calculated from Figure 3.11.5.4-1 in AASHTO (2020) where a portion of the slip surface is modeled as a logarithmic spiral, the backslope is horizontal and the passive soil/concrete interface friction angle is equal to 60 percent of the soil's friction angle.

The recommended passive earth pressure resistances are presented in terms of an equivalent fluid unit weight for moist and saturated conditions. The recommended passive earth pressure values assume mobilization of the nominal soil/concrete foundation interface shear strength. A suitable resistance factor should be included in the design to limit the strain, which will occur at the nominal shear strength, particularly in the case of passive resistance. The resultant passive earth force, calculated from the equivalent fluid unit weight, should be applied at a point located 1/3 of the height of the soil (in contact with the foundation) above the base of the foundation, directed upward at an angle of 20 degrees from the horizontal.



**Table 6. Passive Soil Resistance for CBC**

	Soil Type	Nominal Resistance	Resistance Factor
Passive Soil Resistance	Moist	324 psf/ft	0.50
	Saturated	160 psf/ft	0.50

### 3.5 Lateral Earth Pressures

External loads used in the analyses of the bridge abutments and CBC wing walls should include earth pressure loads, traffic loads, and any other potential surcharge loads. Typical drainage details consisting of inlets near the abutments, geocomposite strip drains, and perforated pipes shall be included in the design to properly contain and transfer surface and subsurface water without saturating the soil around the abutments.

All abutment and CBC wing wall backfill materials should meet the requirements for CDOT Structure Backfill Class 1 in accordance with CDOT (2019). All backfill adjacent to the abutments and walls shall be placed and compacted in accordance with CDOT (2019). It is recommended that compaction of backfill materials be observed and evaluated by an experienced Contractor’s engineer or Contractor’s engineer’s representative.

A lateral wall movement or rotation of approximately 0.1 to 0.2 percent of the wall height may be required to mobilize active earth pressure for the recommended backfill materials. If the estimated wall movement is less than this amount, an at-rest soil pressure should be used in design. In order to mobilize passive earth pressure, lateral wall movement or rotation of approximately 1.0 to 2.0 percent of the wall height may be required for the recommended backfill materials. It should be carefully considered if this amount of movement can be accepted before passive earth pressure is used in the design.

Earth pressure loading within and along the back of the bridge abutments and CBC wing walls shall be controlled by the structural backfill. We recommend that active, at-rest, and passive lateral earth pressures used for the design of the structures be based on an effective angle of internal friction of 34 degrees, and a unit weight of 135 pounds per cubic foot (pcf) for CDOT Structure Backfill Class 1. The following can be used for design assuming a horizontal backslope:

- Active earth pressure coefficient ( $k_a$ ) of 0.28
- Passive earth pressure coefficient ( $k_p$ ) of 3.53
- At-rest earth pressure coefficient ( $k_0$ ) of 0.44

Lateral earth pressures for a non-horizontal backslope can be estimated using section 3.11 in AASHTO (2020).

### 3.6 Bridge Scour Parameters

A bulk sample of the creek bed soils/rock below the existing bridge was collected for gradation analysis. The results of the grain size analysis are presented in Appendix C.



#### 4 BRIDGE APPROACH PAVEMENT

Pavement borings were located approximately 250 feet beyond the existing bridge abutments on each side. Prior to drilling, the existing pavement was cored with a 4-inch nominal diameter core barrel. Photos of the pavement core, logs of the subsurface soils/rock, and results of geotechnical and analytical laboratory testing are presented in the appendices. Bulk soil samples were collected from the pavement borings and combined for classification, strength (R-value), and analytical testing. Preliminary pavement thickness design will be completed by CDOT Staff Materials. The asphalt pavement thicknesses, aggregate base thicknesses (if present), subgrade soil classifications, and subgrade R-values are presented in Table 7.

**Table 7. Existing Pavement Section and Subgrade Properties**

Boring ID	Existing Asphalt Concrete Thickness (in)	Aggregate Base Thickness (in)	Subgrade Soil Classification (AASHTO) <sup>1</sup>	R-Value <sup>1</sup>
M-21-C-P-1	5.0	Not Encountered	A-6 (1)	20
M-21-C-P-2	4.0	Not Encountered		

Note: <sup>1</sup> Subgrade Classification and R-value test results based on combined bulk sample from each pavement boring

#### 5 ANALYTICAL TEST RESULTS

Analytical testing was completed on representative samples of soils encountered in the borings. The test results can be found in Appendix C and are summarized in Table 8. The Analytical results should be used to select the proper concrete type for the project in accordance with CDOT Standard Specifications (2019). A qualified corrosion engineer should review the laboratory data and boring logs to determine the appropriate level of corrosion protection for materials in contact with these soils.

**Table 8. Analytical Test Results**

Sample Boring ID	Material	Water Soluble Sulfates, %	Water Soluble Chlorides, %	pH	Resistivity, ohm-cm
M-21-C-P-1/P-2	Clayey Gravel (Fill)	1.316	0.0012	-	-
M-21-C-B-1	Lean Clay	1.444	0.0079	7.6	697
M-21-C-B-2	Shale	0.152	0.0007	7.8	646

#### 6 SEISMIC CONSIDERATIONS

No active faults are known to exist in the immediate vicinity of the proposed bridge location. Based on the site class definitions provided in Table 3.10.3.1-1 of AASHTO LRFD (2020), the site can be categorized as Site Class D. Also based on the recommendations in Table 3.10.6-1 of AASHTO LRFD (2020), the bridge site can be classified as Seismic Zone 1.



The peak ground acceleration (PGA) and the short- and long- period spectral acceleration coefficients ( $S_s$  and  $S_1$ , respectively) for Site Class B (reference site class) were determined using the seismic design maps from the USGS website. The seismic design parameters for Site Class D are shown in Table 9.

**Table 9. Seismic Design Parameters**

PGA (0.0 sec)	$S_s$ (0.2 sec)	$S_1$ (1.0 sec)
0.047	0.101	0.031
$A_s$ (0.0 sec)	$S_{Ds}$ (0.2 sec)	$S_{D1}$ (1.0 sec)
0.074	0.162	0.075

## 7 LIMITATIONS

Our scope of services was performed, and this report was prepared in accordance with generally accepted principles and practices in this area at the time this report was prepared. We make no other warranty, either express or implied.

The classifications, conclusions, and recommendations submitted in this report are based on the data obtained from published and unpublished maps, reports, and geotechnical analyses. Our conclusions and recommendations are based on our understanding of the project as described in this report and the site conditions as interpreted from the explorations. This data may not necessarily reflect variations in the subsurface conditions and water levels occurring at other locations.

The nature and extent of subsurface variations may not become evident until excavation is performed. Variations in the data may also occur with the passage of time. If during construction, fill, soil, rock, or groundwater conditions appear to be different from those described in this report, this office should be advised immediately so we could review these conditions and reconsider our recommendations. If there is a substantial lapse of time between the submission of this report and the start of work at the site, or if conditions have changed because of natural forces or construction operations at or adjacent to the site, we recommend that this report be reviewed to determine the applicability of the conclusions and recommendations concerning the changed conditions or time lapse. We recommend on-site observation of foundation excavations and foundation subgrade conditions by an experienced geotechnical engineer or engineer's representative.

The scope of services of this study did not include hazardous materials sampling or environmental sampling, investigation, or analyses. In addition, we did not evaluate the site for potential impacts to natural resources, including wetlands, endangered species, or environmentally critical areas.



## 8 REFERENCES

AASHTO LRFD, 9<sup>th</sup> Edition. AASHTO Load Resistance Factor Design (LRFD) Bridge Design Specifications, Eight Edition. Washington, DC: American Association of State Highway and Transportation Officials. 2020.

Abu-Hejleh, N., O'Neill, M.W., Hanneman, Dennis, Atwooll, W.J., 2003. Improvement of the Geotechnical Axial Design Methodology for Colorado's Drilled Shafts Socketed in Weak Rocks, Final Report: Colorado Department of Transportation Research Branch, July 2003, Report No. CDOT-DTD-R-2003-6.

Colorado Department of Transportation, 2019. CDOT Standard Specifications for Road and Bridge Construction. 2019 Edition.

Federal Highway Administration (FHWA) publications, Geosynthetic Reinforced Soil Integrated Bridge System Interim Implementation Guide, Publication No. FHWA-HRT-11-026, June 2012.

Federal Highway Administration (FHWA) publications, Geosynthetic Reinforced Soil Integrated Bridge System Synthesis Report, Publication No. FHWA-HRT-11-027, January 2011.

Respectfully Submitted,  
**YEH AND ASSOCIATES, INC.**

Prepared by:



Cory S. Wallace, EIT, GIT  
Staff Engineer

Reviewed by:

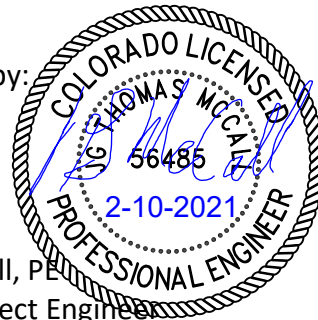

JG T. McCall, PE  
Senior Project Engineer

Independent Technical Review by:



Hsing-Cheng Liu, PE, PhD  
Senior Project Manager

Attachments:

- Appendix A
- Appendix B
- Appendix C



**APPENDIX A**

---

**ENGINEERING GEOLOGY SHEET**



mwalz 10:57:00 AM p:\1\cdot-pw-bentley.com\cdot-pw-01P\Documents\01 Major Projects\R2B2 (REGION 2 BRIDGE BUNDLE)\Legacy Data\23558 - R2B2 (REGION 2 BRIDGE BUNDLE) (GRANT)\Materials\_Geotechnical Drawings\23558GEDT\_Engineering Geology M-21-C

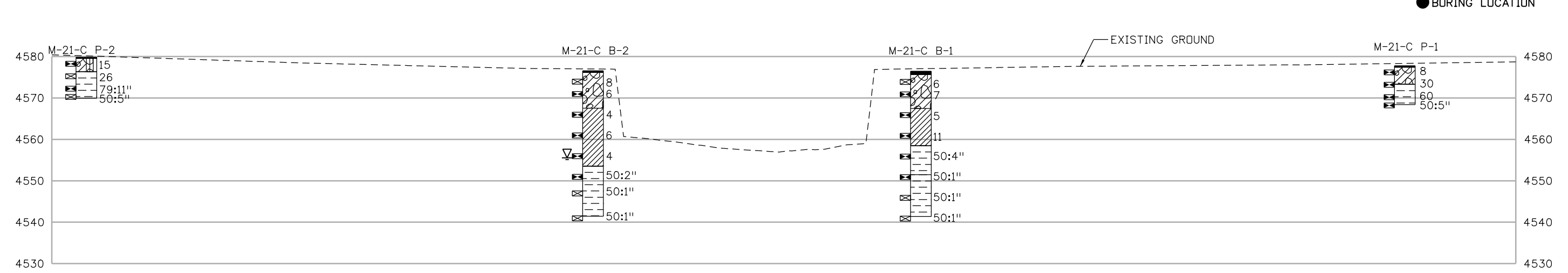
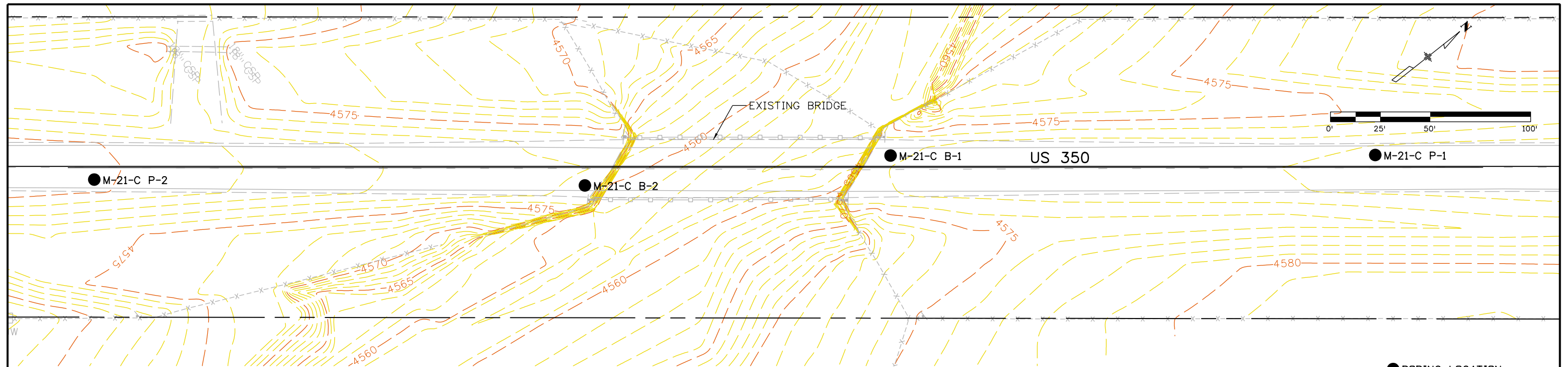

**LEGEND**

Asphalt	USCS Clayey Gravel	USCS Lean/Low Plasticity Clay
USCS Silty, Clayey Gravel	Claystone	Shale

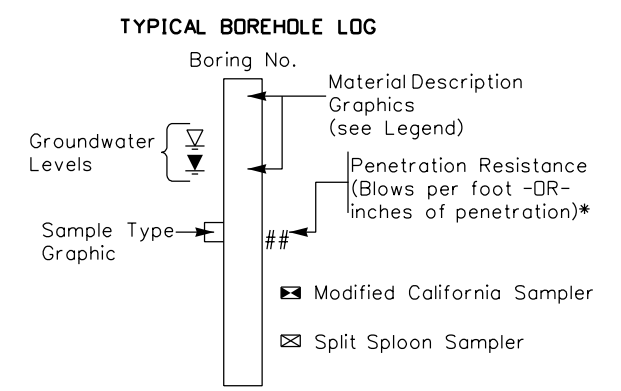

\*e.g. A value of 50/3 or 50:3" indicates that 50 blows were applied to the sampler, with a penetration of 3 inches.

Print Date: 11/13/2020
File Name: 23558GEDT_Engineering Geology M-21-C.dgn
Horiz. Scale: 1:50      Vert. Scale: As Noted
Unit Information      Unit Leader Initials
<b>Yeh and Associates, Inc.</b> Geotechnical - Geological - Construction Services

Sheet Revisions		
Date:	Comments	Init.

**Colorado Department of Transportation**

1480 Quail Lake Loop, Suite A  
Colorado Springs, CO 80906  
Phone: 719-634-2323  
FAX: 719-227-3298

**Region 2**

<b>As Constructed</b>
No Revisions:
Revised:
Void:

<b>R2 BRIDGE BUNDLE ENGINEERING GEOLOGY</b>			
Designer:	JTM	Structure Numbers:	M-21-C
Detailer:	MJW	Subset Sheets:	1 of 1

<b>Project No./Code</b>
STM R200-262
23358
Sheet Number



## **APPENDIX B**

---

**KEY TO BORING LOGS**  
**BORING LOGS**  
**PAVEMENT CORE PHOTOS**



# Legend for Symbols Used on Borehole Logs

## Sample Types



Bulk Sample of auger/odex cuttings



Rock core



Modified California Sampler (2.5 inch OD, 2.0 inch ID)



Standard Penetration Test (ASTM D1586)

## Drilling Methods



CORING



HOLLOW-STEM AUGER



CORING

## Lithology Symbols (see Boring Logs for complete descriptions)



Asphalt



Cobbles and gravel



USCS Fat/High Plasticity Clay



USCS Lean/Low Plasticity Clay



Fill



Fill with Clay as major soil



Fill with Gravel as major soil



USCS Clayey Gravel



USCS Silty, Clayey Gravel



USCS Poorly-graded Gravel



USCS Poorly-graded Gravel with Clay



High Plasticity Sandy Clay



Poorly-graded Sandy Gravel



Low Plasticity Sandy Clay



USCS Clayey Sand



USCS Silty Sand



USCS Poorly-graded Sand



USCS Poorly-graded Sand with Clay



Shale



Weathered Bedrock



Granite



Limestone

## Lab Test Standards

Moisture Content	ASTM D2216
Dry Density	ASTM D7263
Sand/Fines Content	ASTM D421, ASTM C136, ASTM D1140
Atterberg Limits	ASTM D4318
AASHTO Class.	AASHTO M145, ASTM D3282
USCS Class.	ASTM D2487
(Fines = % Passing #200 Sieve)	
Sand = % Passing #4 Sieve, but not passing #200 Sieve)	

## Other Lab Test Abbreviations

pH	Soil pH (AASHTO T289-91)
S	Water-Soluble Sulfate Content (AASHTO T290-91, ASTM D4327)
Chl	Water-Soluble Chloride Content (AASHTO T291-91, ASTM D4327)
S/C	Swell/Collapse (ASTM D4546)
UCCS	Unconfined Compressive Strength (Soil - ASTM D2166, Rock - ASTM D7012)
R-Value	Resistance R-Value (ASTM D2844)
DS (C)	Direct Shear cohesion (ASTM D3080)
DS (phi)	Direct Shear friction angle (ASTM D3080)
Re	Electrical Resistivity (AASHTO T288-91)
PtL	Point Load Strength Index (ASTM D5731)

## Notes

- Visual classifications are in general accordance with ASTM D2488, "Standard Practice for Description and Identification of Soils (Visual-Manual Procedures)".
- "Penetration Resistance" on the Boring Logs refers to the uncorrected N value for SPT samples only, as per ASTM D1586. For samples obtained with a Modified California (MC) sampler, drive depth is 12 inches, and "Penetration Resistance" refers to the sum of all blows. Where blow counts were > 50 for the 3rd increment (SPT) or 2nd increment (MC), "Penetration Resistance" combines the last and 2nd-to-last blows and lengths; for other increments with > 50 blows, the blows for the last increment are reported.
- The Modified California sampler used to obtain samples is a 2.5-inch OD, 2.0-inch ID (1.95-inch ID with liners), split-barrel sampler with internal liners, as per ASTM D3550. Sampler is driven with a 140-pound hammer, dropped 30 inches per blow.
- "ER" for the hammer is the Reported Calibrated Energy Transfer Ratio for that specific hammer, as provided by the drilling company.



**Boring Began: 8/28/2020**

**Total Depth: 9.4 ft**

Weather Notes: Sunny, 91F

**Boring Completed: 8/28/2020**

Ground Elevation: 4577.75

Inclination from Horiz.: Vertical

Drilling Method(s): Coring /

Coordinates: N: 402628.5 E: 481096.6

Solid-Stem Auger

Location: US 350, southbound outside lane

Night Work:

Driller: Vine Laboratories

Logged By: B. Lykins

Drill Rig: CME 750X Buggy

Final By: J. McCall

Hammer: Automatic (hydraulic), ER: 80%

Groundwater Levels: Not Observed

Symbol	Depth	Date
-	-	-
-	-	-

Elevation (feet)	Depth (feet)	Sample Type/Depth	Drilling Method	Soil Samples		Lithology	Material Description	Moisture Content (%)	Dry Density (pcf)	Gravel Content (%)	Sand Content (%)	Fines Content (%)	Atterberg Limits		AASHTO & USCS Classifications	Field Notes and Other Lab Tests	
				Blows per 6 in	Penetration Resistance								Liquid Limit	Plasticity Index			
							0.0 - 0.4 ft. ASPHALT (5 inches).										
				3-5	8		0.4 - 4.5 ft. Clayey GRAVEL with sand (GC), light brown to brown, moist, loose.	7.7		42.0	29.1	28.9	25	11	A-2-6 (0) GC		
4575	5			9-21	30		4.5 - 9.0 ft. DECOMPOSED SHALE, orange-brown with gray, predominantly decomposed, hard.	10.0		6.0	17.5	76.5	39	23	A-6 (16) CL	S=1.316% Ch=0.0012%	S/C=4.1%
4570				20-40	60												
				50:5"	50:5"		9.0 - 9.4 ft. SHALE, orange-brown with gray, moderately weathered, very hard.										
							Bottom of Hole at 9.4 ft.										
4565																	
4560																	
4555																	

BORING LOG 2019 - SPT CDOT STYLE 220-063 R2 BRIDGE BUNDLE.GPJ 2019 YEH COLORADO TEMPLATE.GDT 2019 YEH COLORADO LIBRARY.GLB 11/6/20



**Boring Began: 8/28/2020**

**Total Depth: 9.9 ft**

Weather Notes: Sunny, 85F

**Boring Completed: 8/28/2020**

Ground Elevation: 4579.83

Inclination from Horiz.: Vertical

Drilling Method(s): Coring /

Coordinates: N: 402118.1 E: 480711.2

Solid-Stem Auger

Location: US 350, northbound outside lane

Night Work:

Driller: Vine Laboratories

Logged By: B. Lykins

Drill Rig: CME 750X Buggy

Final By: J. McCall

Hammer: Automatic (hydraulic), ER: 80%

Groundwater Levels: Not Observed

Symbol	Depth	Date
-	-	-
-	-	-

Elevation (feet)	Depth (feet)	Sample Type/Depth	Drilling Method	Soil Samples		Lithology	Material Description	Moisture Content (%)	Dry Density (pcf)	Gravel Content (%)	Sand Content (%)	Fines Content (%)	Atterberg Limits		AASHTO & USCS Classifications	Field Notes and Other Lab Tests	
				Blows per 6 in	Penetration Resistance								Liquid Limit	Plasticity Index			
							0.0 - 0.3 ft. ASPHALT (4 inches).										
				6-9	15		0.3 - 3.5 ft. Silty, clayey GRAVEL with sand (GC-GM), light brown with white, moist, medium dense.	10.0		35.0	30.8	34.2	25	7	A-2-4 (0) GC-GM		
4575	5			7-12-14	26		3.5 - 9.9 ft. DECOMPOSED SHALE, orange-brown with gray, predominantly decomposed, firm to hard.										S=1.316% Ch=0.0012%
				29-50:5"	79:11"												
4570				25-50:5"	50:5"												
Bottom of Hole at 9.9 ft.																	
4565																	
4560																	
4555																	

BORING LOG 2019 - SPT CDOT STYLE 220-063 R2 BRIDGE BUNDLE.GPJ 2019 YEH COLORADO TEMPLATE.GDT 2019 YEH COLORADO LIBRARY.GLB 11/6/20



**Boring Began: 8/28/2020**  
**Boring Completed: 8/28/2020**  
Drilling Method(s): Hollow-Stem Auger  
Driller: Vine Laboratories  
Drill Rig: CME 750X Buggy  
Hammer: Automatic (hydraulic), ER: 80%

**Total Depth: 35.1 ft**  
Ground Elevation: 4576.46  
Coordinates: N: 402438.1 E: 480947.3  
Location: US 350, southbound outside lane  
Logged By: B. Lykins  
Final By: J. McCall

**Weather Notes:**  
Inclination from Horiz.: Vertical  
Night Work:

Groundwater Levels: Not Observed			
Symbol	-	-	-
Depth	-	-	-
Date	-	-	-

Elevation (feet)	Depth (feet)	Sample Type/Depth	Drilling Method	Soil Samples		Lithology	Material Description	Moisture Content (%)	Dry Density (pcf)	Gravel Content (%)	Sand Content (%)	Fines Content (%)	Atterberg Limits		AASHTO & USCS Classifications	Field Notes and Other Lab Tests
				Blows per 6 in	Penetration Resistance								Liquid Limit	Plasticity Index		
							0.0 - 0.8 ft. ASPHALT (9 inches).									
4575				6-3-3	6		0.8 - 9.0 ft. Clayey GRAVEL with sand (GC), tan to light brown, moist, loose.									
	5			3-4	7											
4570																
	10			2-3	5		9.0 - 18.0 ft. Lean CLAY with sand (CL), light brown to orange-brown, moist, soft to medium stiff.									
4565																
	15			3-8	11			16.6		0.0	19.0	81.0	34	20	A-6 (14) CL	pH=7.6 S=1.444% ChI=0.0079% Re=697ohm-cm
4560																
	20			50:4"	50:4"		18.0 - 35.1 ft. SHALE, orange-brown with gray, moderately weathered, very hard.	7.6			22.0	78.0				UCCS=162.1 psi
4555																

BORING LOG 2019 - SPT CDOT STYLE 220-063 R2 BRIDGE BUNDLE.GPJ 2019 YEH COLORADO TEMPLATE.GDT 2019 YEH COLORADO LIBRARY.GLB 11/6/20



Elevation (feet)	Depth (feet)	Sample Type/Depth	Drilling Method	Soil Samples		Lithology	Material Description	Moisture Content (%)	Dry Density (pcf)	Gravel Content (%)	Sand Content (%)	Fines Content (%)	Atterberg Limits		AASHTO & USCS Classifications	Field Notes and Other Lab Tests
				Blows per 6 in	Penetration Resistance								Liquid Limit	Plasticity Index		
4550				50:1"	50:1"											
4545	30			50:1"	50:1"											
4540				50:1"	50:1"											
4535																
4530																
4525																
							Bottom of Hole at 35.1 ft.									

BORING LOG 2019 - SPT CDOT STYLE 220-063 R2 BRIDGE BUNDLE.GPJ 2019 YEH COLORADO TEMPLATE.GDT 2019 YEH COLORADO LIBRARY.GLB 11/6/20



**Boring Began: 8/28/2020**  
**Boring Completed: 8/28/2020**  
 Drilling Method(s): Hollow-Stem Auger / Solid-Stem Auger  
 Driller: Vine Laboratories  
 Drill Rig: CME 750X Buggy  
 Hammer: Automatic (hydraulic), ER: 80%

**Total Depth: 35.1 ft**  
 Ground Elevation: 4576.54  
 Coordinates: N: 402308.9 E: 480864.8  
 Location: US 350 northbound outside lane  
 Logged By: B. Lykins  
 Final By: J. McCall

Weather Notes: Sunny, 82F  
 Inclination from Horiz.: Vertical  
 Night Work:

Groundwater Levels:			
Symbol	∇		
Depth	21.0 ft	-	-
Date	8/28/20	-	-

Elevation (feet)	Depth (feet)	Sample Type/Depth	Drilling Method	Soil Samples		Lithology	Material Description	Moisture Content (%)	Dry Density (pcf)	Gravel Content (%)	Sand Content (%)	Fines Content (%)	Atterberg Limits		AASHTO & USCS Classifications	Field Notes and Other Lab Tests
				Blows per 6 in	Penetration Resistance								Liquid Limit	Plasticity Index		
4575																
	5			9-5-3	8		0.0 - 0.4 ft. ASPHALT (4 inches). 0.4 - 9.0 ft. Clayey GRAVEL (GC), light brown, moist, loose.									
4570				3-3	6			11.8		37.0	27.1	35.9	29	12	A-6 (1) GC	
4565	10			2-2	4		9.0 - 23.0 ft. Lean CLAY (CL), light brown with gray, moist, soft to medium stiff.	23.4		1.0	10.7	88.3	37	20	A-6 (17) CL	UCCS=10.8 psi
4560	15			3-3	6											
4555	20			2-2	4		- turning dark gray to black, organic material (roots), hydrocarbon odor.									
							23.0 - 35.1 ft. SHALE, dark brown, moderately weathered, very hard.									

BORING LOG 2019 - SPT CDOT STYLE 220-063 R2 BRIDGE BUNDLE.GPJ 2019 YEH COLORADO TEMPLATE.GDT 2019 YEH COLORADO LIBRARY.GLB 11/6/20



Elevation (feet)	Depth (feet)	Sample Type/Depth	Drilling Method	Soil Samples		Lithology	Material Description	Moisture Content (%)	Dry Density (pcf)	Gravel Content (%)	Sand Content (%)	Fines Content (%)	Atterberg Limits		AASHTO & USCS Classifications	Field Notes and Other Lab Tests
				Blows per 6 in	Penetration Resistance								Liquid Limit	Plasticity Index		
4550				50:2"	50:2"											pH=7.8 S=0.152% ChI=0.0007% Re=646ohm-cm
30				50:1"	50:1"											
4545																
35				50:1"	50:1"		Bottom of Hole at 35.1 ft.									
4540																
4535																
4530																
4525																

BORING LOG 2019 - SPT CDOT STYLE 220-063 R2 BRIDGE BUNDLE.GPJ 2019 YEH COLORADO TEMPLATE.GDT 2019 YEH COLORADO LIBRARY.GLB 11/6/20





Boring:	<b>P-1</b>	AC:	<b>5"</b>
Roadway:	<b>US 350</b>	PCC:	-
Direction:	<b>Southbound</b>	Base:	-
Lane:	<b>Outside</b>	Notes:	-



Boring:	<b>P-2</b>	AC:	<b>4"</b>
Roadway:	<b>US 350</b>	PCC:	-
Direction:	<b>Northbound</b>	Base:	-
Lane:	<b>Outside</b>	Notes:	-



**Yeh and Associates, Inc.**  
Geotechnical • Geological • Construction Services

**Pavement Core Photographs**

FIGURE

PROJECT NO. 220-063 DATE: 10/19/2020  
 FIGURE BY: BHL YEHE OFFICE: Colorado Springs  
 CHECKED BY: JTM

CDOT Region 2 Bridge Bundle  
 Structure M-21-C

**B-1**

## APPENDIX C

---

### SUMMARY OF LABORATORY TEST RESULTS







## Summary of Laboratory Test Results

Project No: 220-063      Project Name: CDOT Region 2 Bridge Bundle      Date: 01-04-2021

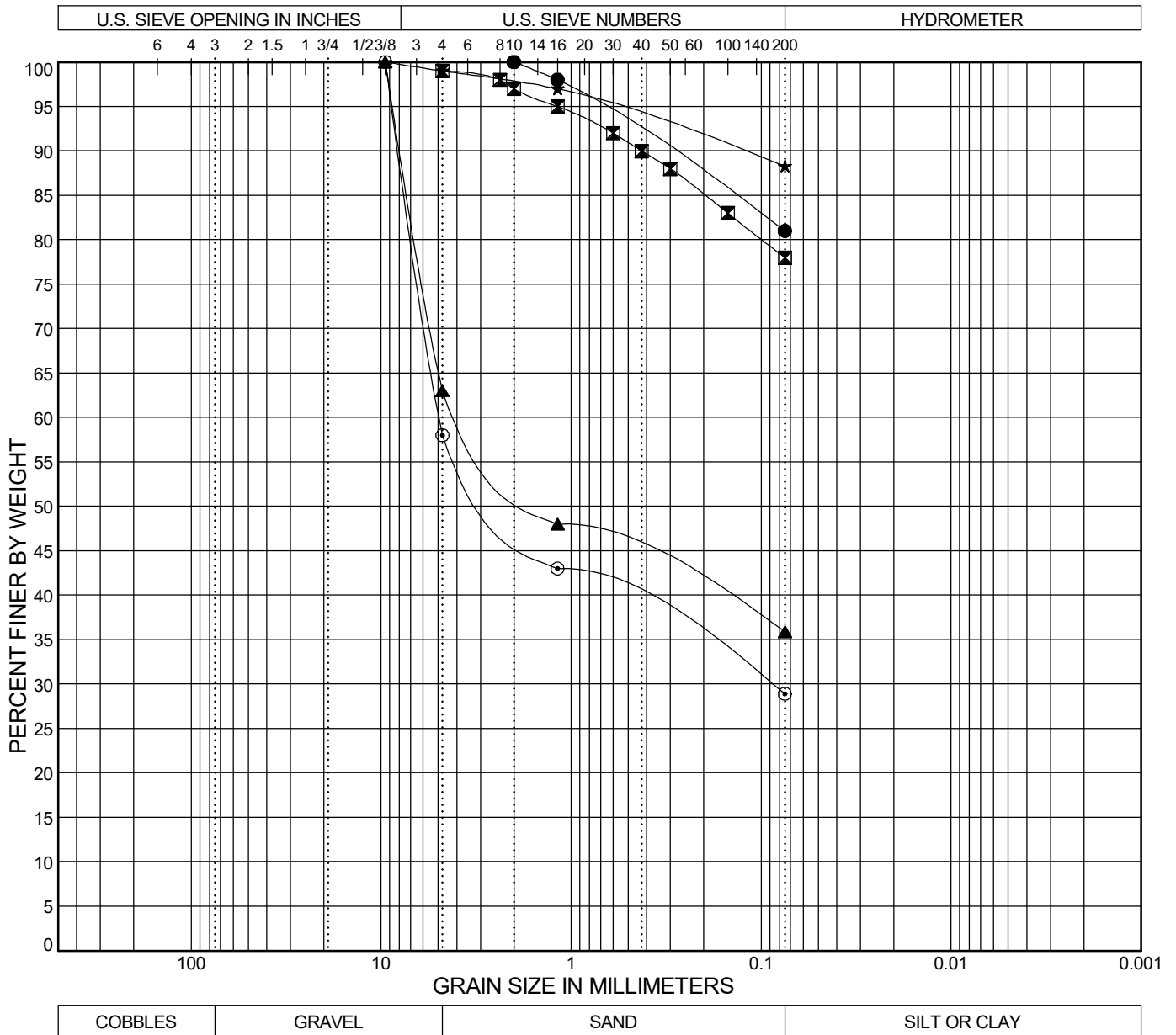
Sample Location			Natural Moisture Content (%)	Natural Dry Density (pcf)	Gradation			Atterberg			pH	Water Soluble Sulfate (%)	Water Soluble Chloride (%)	Resistivity (ohm-cm)	Swell (+) / Collapse (-) (% at Load in psf)	Unconf. Comp. Strength (psi)	R-Value	Classification	
Boring No.	Depth (ft)	Sample Type			Gravel > #4 (%)	Sand (%)	Fines < #200 (%)	LL	PL	PI								AASHTO	USCS
M-21-C B-1	15.0	MC	16.6	111.1	0.0	19.0	81.0	34	14	20	7.6	1.444	0.0079	697				A-6 (14)	CL
M-21-C B-1	20.0	MC	7.6	123.8		22.0	78.0									162.1			
M-21-C B-2	5.0	MC	11.8	116.7	37.0	27.1	35.9	29	17	12								A-6 (1)	GC
M-21-C B-2	10.0	MC	23.4	96.9	1.0	10.7	88.3	37	17	20						10.8		A-6 (17)	CL
M-21-C B-2	25.0	MC									7.8	0.152	0.0007	646					
M-21-C P-1	1.0	MC	7.7	123.0	42.0	29.1	28.9	25	14	11								A-2-6 (0)	GC
M-21-C P-1	2.5	BULK																	
M-21-C P-1	4.0	MC	10	122.9	6.0	17.5	76.5	39	16	23					4.1 @ 200			A-6 (16)	CL
M-21-C P-1/P-2	2.5	BULK	7.4		17.0	46.1	36.9	25	13	12		1.316	0.0012				20	A-6 (1)	SC
M-21-C Scour	0	BULK	3.5		72.0	20.1	7.9												
M-21-C-P-2	1.0	MC	10	118.7	35.0	30.8	34.2	25	18	7								A-2-4 (0)	GC-GM



BOREHOLE	DEPTH (ft)	AASHTO Classification	USCS Classification	LL	PL	PI	%Gravel	%Sand	%Fines	
									%Silt	%Clay
● M-21-C B-1	15.0	A-6 (14)	CL	34	14	20	0.0	19.0	81.0	
■ M-21-C B-1	20.0							21.0	78.0	
▲ M-21-C B-2	5.0	A-6 (1)	GC	29	17	12	37.0	27.1	35.9	
★ M-21-C B-2	10.0	A-6 (17)	CL	37	17	20	1.0	10.7	88.3	
◎ M-21-C P-1	1.0	A-2-6 (0)	GC	25	14	11	42.0	29.1	28.9	

 <b>Yeh and Associates, Inc.</b> Geotechnical • Geological • Construction Services	<h2>SIEVE ANALYSIS</h2>	<h2>FIGURE</h2>

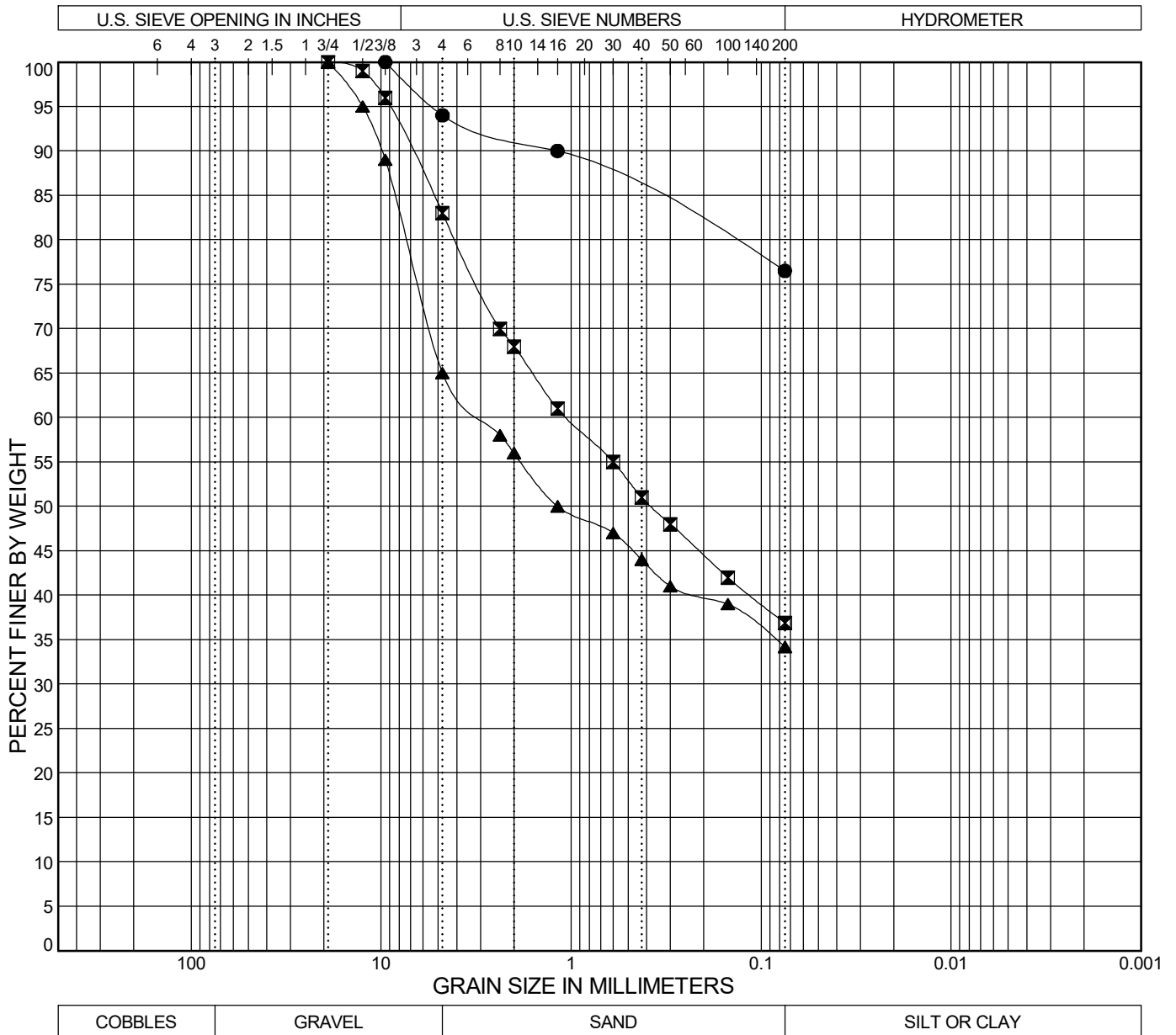

BOREHOLE	DEPTH (ft)	AASHTO Classification	USCS Classification	LL	PL	PI	%Gravel	%Sand	%Fines	
									%Silt	%Clay
● M-21-C P-1	4.0	A-6 (16)	CL	39	16	23	6.0	17.5	76.5	
☒ M-21-C P-1/P-2	2.5	A-6 (1)	SC	25	13	12	17.0	46.1	36.9	
▲ M-21-C-P-2	1.0	A-2-4 (0)	GC-GM	25	18	7	35.0	30.8	34.2	

 <b>Yeh and Associates, Inc.</b> Geotechnical • Geological • Construction Services	<h2>SIEVE ANALYSIS</h2>	<h2>FIGURE</h2>

03 GRAIN SIZE YEH 220-063 R2 BRIDGE BUNDLE FIXED FORMATTING 12-11-2020.GPJ 2019 YEH COLORADO TEMPLATE.GDT 2019 YEH COLORADO LIBRARY.GLB 1/4/21

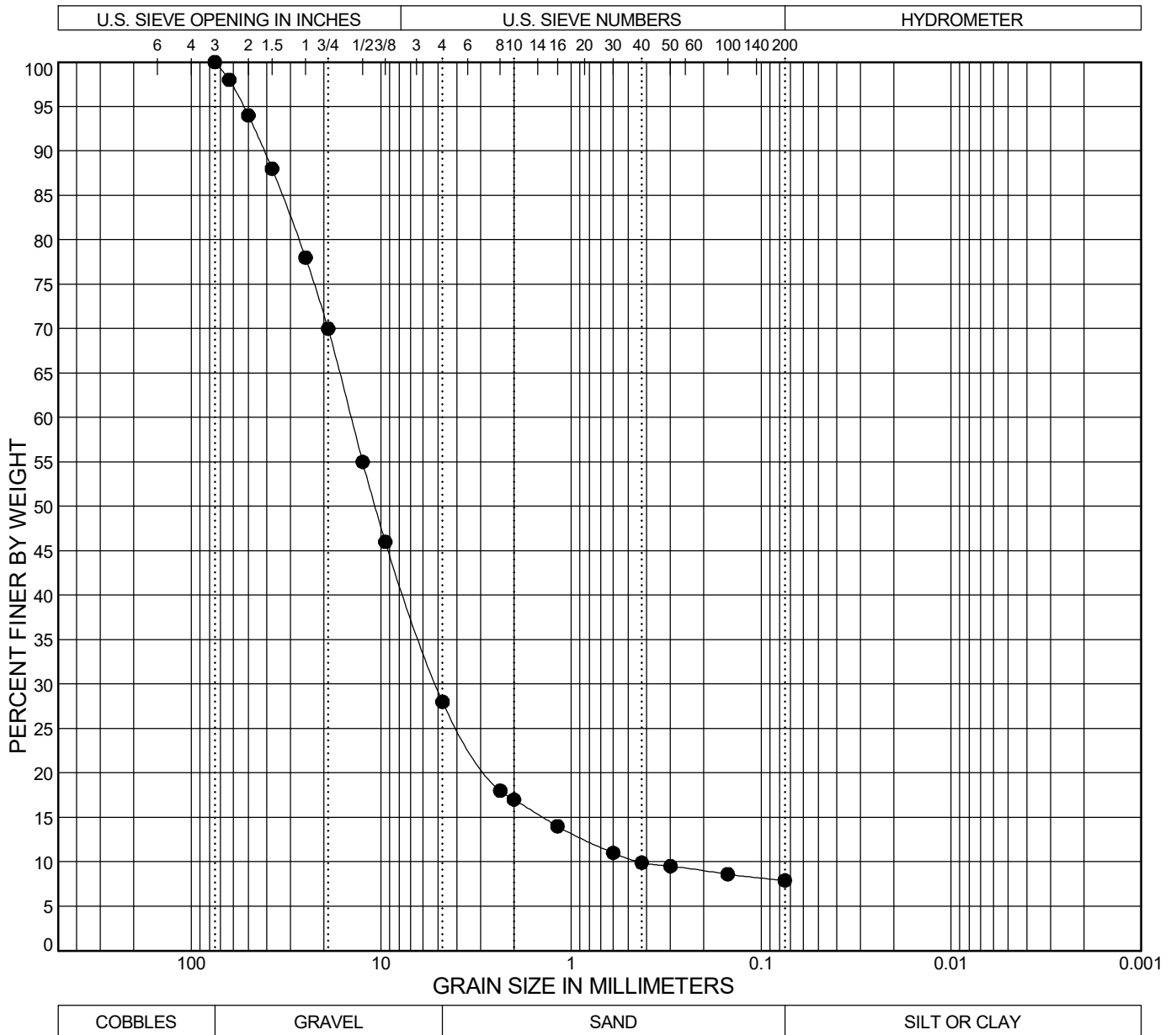

BOREHOLE	DEPTH (ft)	AASHTO Classification	USCS Classification	LL	PL	PI	%Gravel	%Sand	%Fines	
									%Silt	%Clay
● M-21-C Scour	0.0						72.0	20.1	7.9	

 <b>Yeh and Associates, Inc.</b> Geotechnical • Geological • Construction Services	<h2>SIEVE ANALYSIS</h2>	<h2>FIGURE</h2>

01 ATTERBERG LIMITS YEH - ALL BORINGS 220-063 R2 BRIDGE BUNDLE FIXED FORMATTING 12-11-2020.GPJ 2019 YEH COLORADO TEMPLATE.GDT 2019 YEH COLORADO LIBRARY.GLB 1/4/21

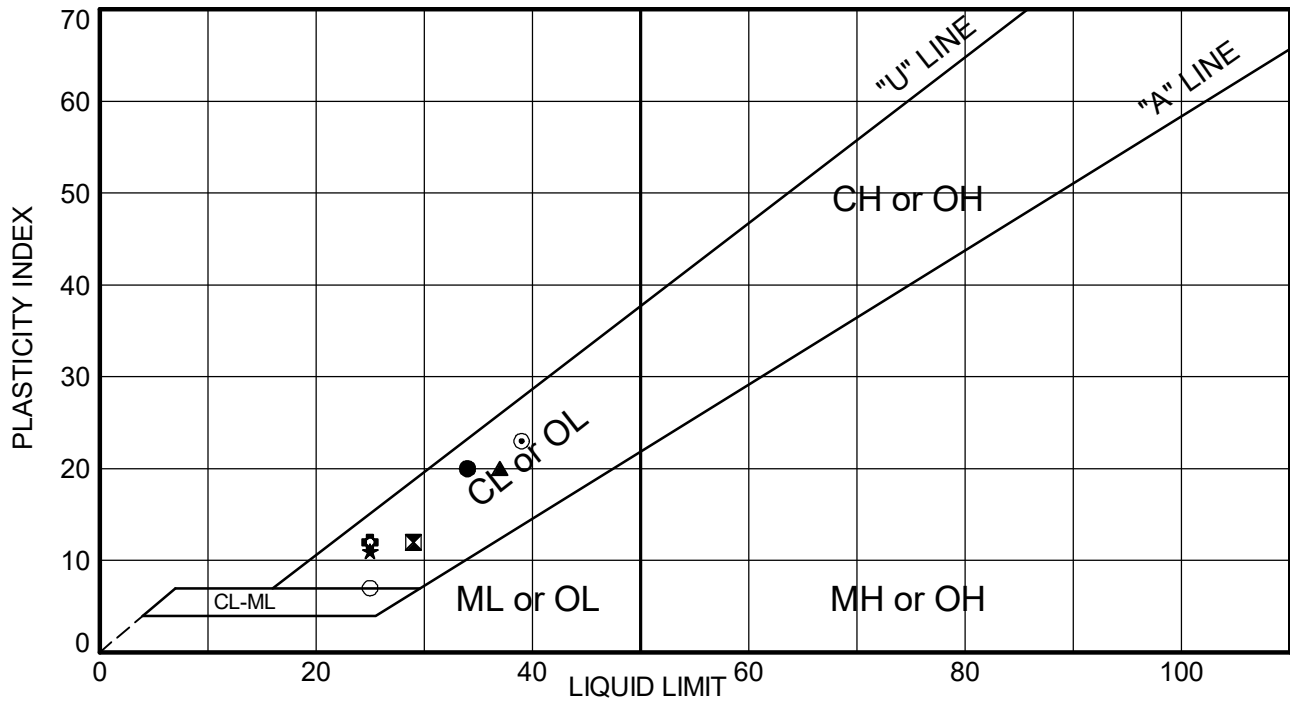

BOREHOLE	DEPTH (ft)	LL	PL	PI	Passing #200	USCS Sample Description and Symbol	AASHTO Class.
● M-21-C B-1	15.0	34	14	20	81.0	LEAN CLAY with SAND (CL)	A-6 (14)
☒ M-21-C B-2	5.0	29	17	12	35.9	CLAYEY GRAVEL with SAND (GC)	A-6 (1)
▲ M-21-C B-2	10.0	37	17	20	88.3	LEAN CLAY (CL)	A-6 (17)
★ M-21-C P-1	1.0	25	14	11	28.9	CLAYEY GRAVEL with SAND (GC)	A-2-6 (0)
◎ M-21-C P-1	4.0	39	16	23	76.5	LEAN CLAY with SAND (CL)	A-6 (16)
⊕ M-21-C P-1/P-2	2.5	25	13	12	36.9	CLAYEY SAND with GRAVEL (SC)	A-6 (1)
○ M-21-C-P-2	1.0	25	18	7	34.2	SILTY, CLAYEY GRAVEL with SAND (GC-GM)	A-2-4 (0)



**ATTERBERG LIMITS**

**FIGURE**

Project No. 220-063 Date: 01-04-2021  
 Report By: D. Gruenwald Yeh Lab: Colorado Springs  
 Checked By: J. McCall

CDOT Region 2 Bridge Bundle  
 Structure M-21-C

**C - 4**

**SWELL/CONSOLIDATION TEST - ASTM D 4546**

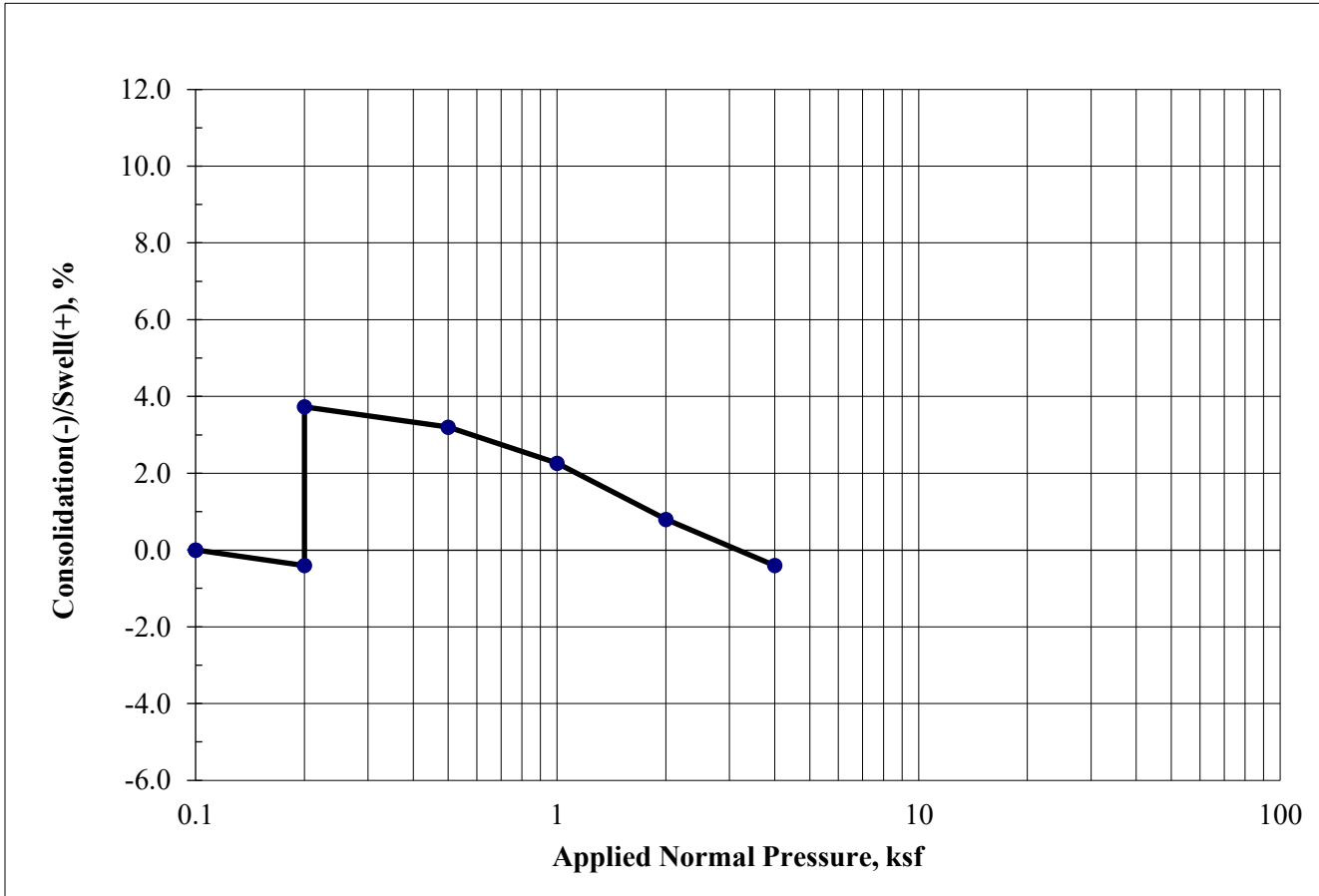

<b>Boring ID</b>	P-1
<b>Sample Depth (ft)</b>	4.0
<b>Date Sampled</b>	8/28/2020

<b>Swell/ Consolidation (%)</b>	4.1
<b>Natural Moisture Content (%)</b>	10
<b>Saturated Moisture Content (%)</b>	17.8
<b>Dry Density (pcf)</b>	122.9

 <b>Yeh and Associates, Inc.</b> Geotechnical • Geological • Construction Services	<b>SWELL/ CONSOLIDATION TEST RESULTS</b>		<b>FIGURE C-5</b>
	Project No. 220-063      Date: 1/4/2021 Report By: DG              Yeh Lab: Colorado Springs Checked By: JTM	CDOT Region 2 Bridge Bundle Structure M-21-C	





**STRESS-STRAIN CURVE  
OF COHESIVE SOIL (ASTM D 2166)**

Project No: 220-063 Project Name: CDOT Region 2 Bridge Bundle M-21-C  
 Sampled by: JTM Date Sampled: 9/23/2020 Date Tested: 10/7/20  
 Boring No: B-2 Depth (ft): 10 Blow Counts: \_\_\_\_\_  
 Tested by: M.A Checked by: JTM  
 Soil Classification: \_\_\_\_\_

Axial Strain (%)	Axial Stress (psf)
0.0%	0.0
0.3%	68.9
0.5%	132.5
0.8%	195.8
1.0%	249.0
1.3%	267.9
1.6%	349.7
1.8%	411.8
2.1%	478.4
2.3%	520.5
2.6%	586.4
2.8%	642.3
3.1%	693.2
3.4%	758.1
3.6%	803.6
3.9%	848.9
4.1%	889.2
4.4%	938.7
4.7%	954.9
4.9%	1004.0
5.2%	1038.6
5.4%	1087.1
5.7%	1116.7
6.0%	1146.1
6.2%	1170.8
6.5%	1195.2
6.7%	1214.9
7.0%	1271.2
7.3%	1308.8
7.5%	1360.0
7.8%	1374.3
8.0%	1406.8
8.3%	1434.5
8.5%	1484.6
<b>8.8%</b>	<b>1556.9</b>
9.1%	1498.6
9.3%	1387.0
9.6%	1276.0
9.8%	1089.9

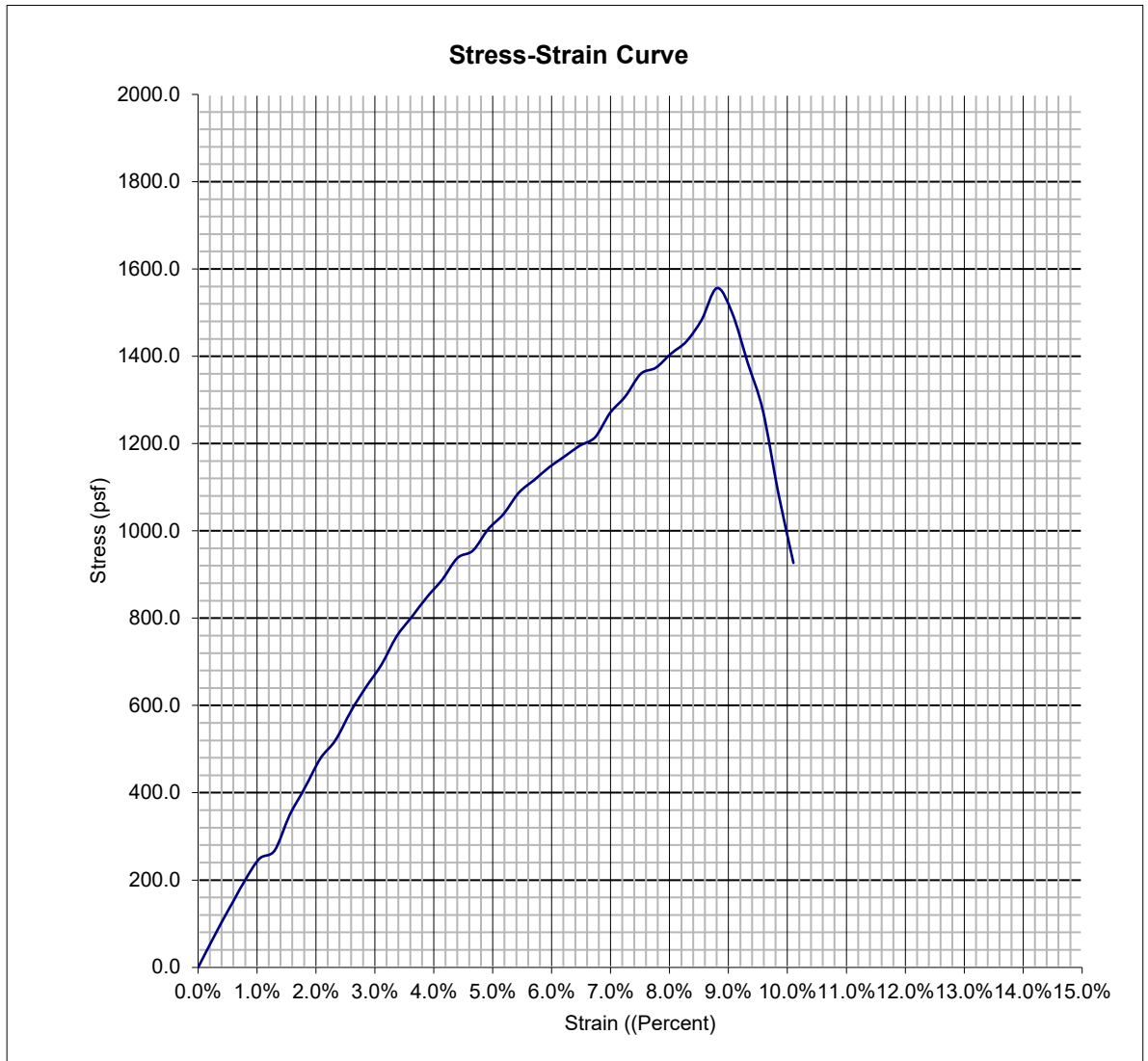

**Unconfined Compressive Strength ( $q_u$ ) = 1557 psf @ 8.8% Strain**

**Natural Moisture:** 23.4 %  
**Natural Density(Dry):** 96.9 pcf  
**Average Diameter (D):** 1.928 inches  
**Average High (L):** 3.862 inches  
**L/D Ratio:** 2.00



# YEH AND ASSOCIATES, INC

## R-Value Test Report

**Project Number:** 220-063  
**Sample Id:** P-1 / P-2  
**Location:** M-21-C  
**Date Sampled:** 9/23/2020

**Project Name:** CDOT R2 Bridge Bundle  
**Depth (ft):** 2.5  
**Station:** 0  
**Date Tested:** 10/6/2020

**R-Value at 300 psi exudation pressure =** 20

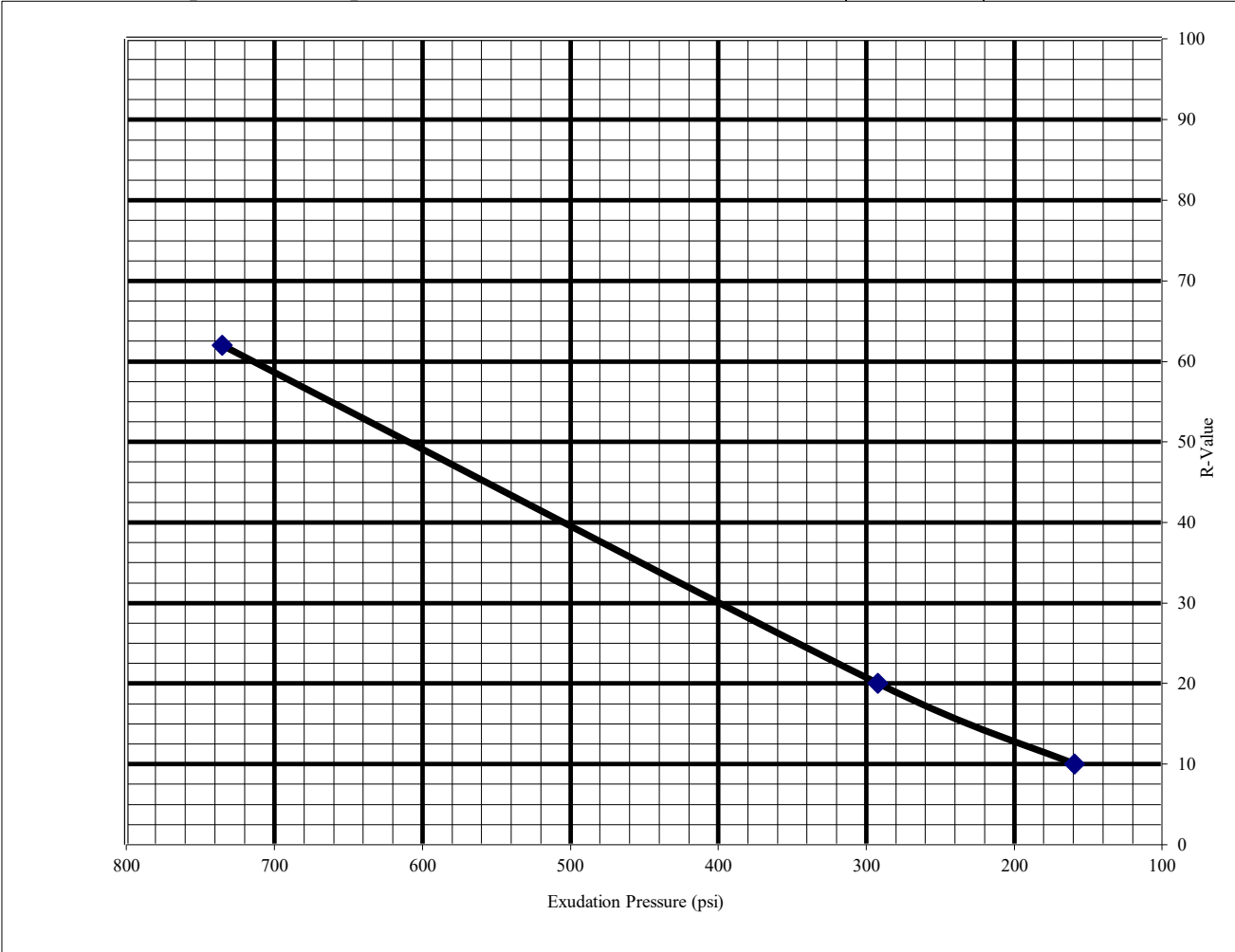

Test No.	Compact. Press. (psi)	Density (pcf)	Moist. (%)	Horizont. Pressure (psi)@ 160 psi	Sample Height (in.)	Exud. Pressure (psi)	R Value	R Value Correct.
1	350	132.1	7.0	52	2.47	735	62	62
2	350	132.3	9.0	117	2.53	292	20	20
3	350	131.3	11.0	136	2.46	159	10	10

**Sampled by:** JTM

**Tested by:** Kyle Lyons

**Checked by:** M.A